

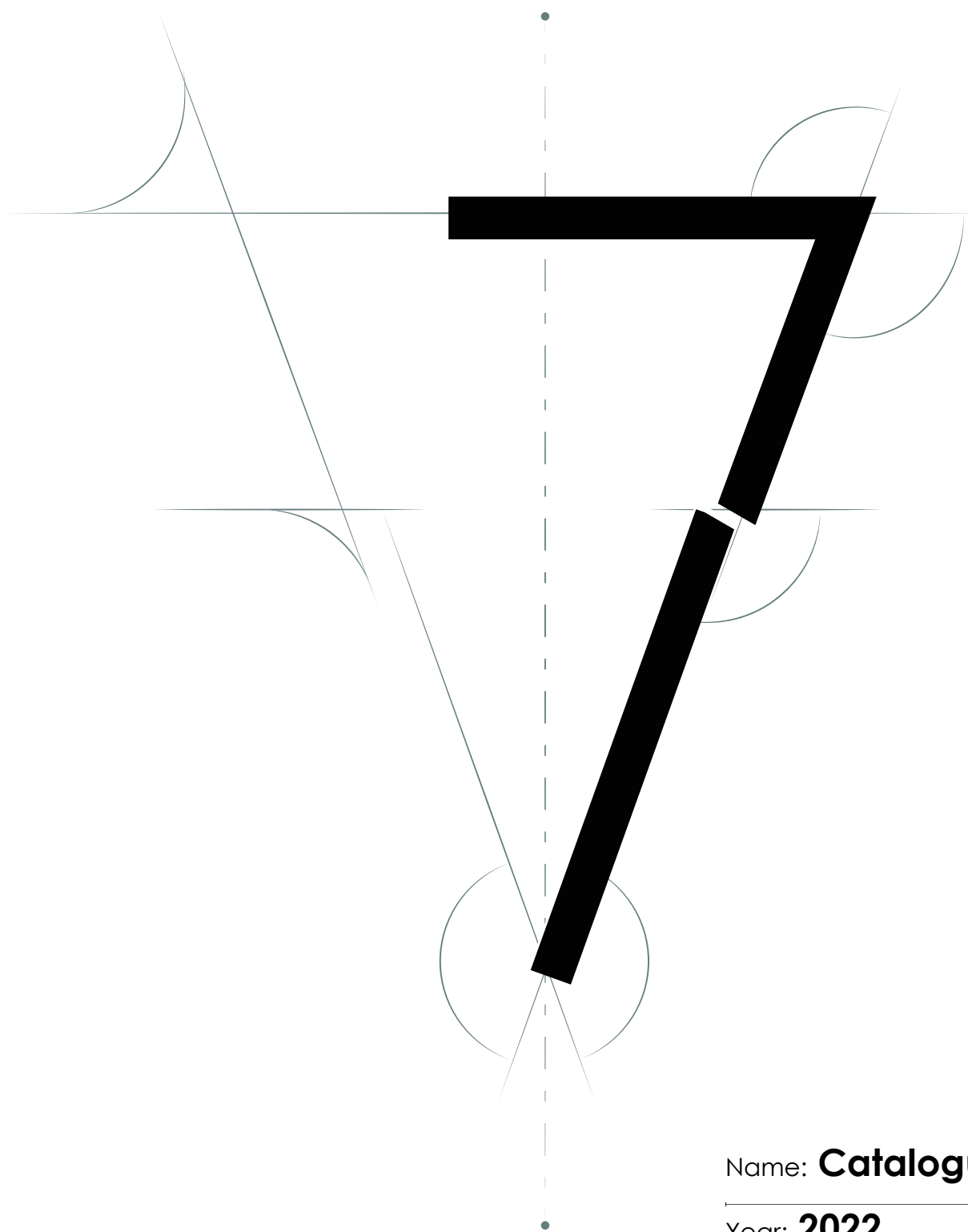

Name: **Catalogue 7**

Year: **2022**

Company: **Civic s.r.l.**



Name: **Catalogue 7**

Year: **2022**

Company: **Civic s.r.l.**

PRODUTTORI

MANUFACTUR

VENDITORI SEL

CONSULENTI C

WE ARE CIVIC

MULTILANGUA

PROFESSIONIS

PROFESSIONA

ERS ARTIGIANI

LLERS

CONSULTANTS

MULTILINGUA

AGE

TI

LS

28 YEARS OF EXPERIENCE

ANNI DI ESPERIENZA

*La luce è stata il passato,
è il presente,
sarà il nostro futuro.*

PROGETTIAMO OGGI LE SOLUZIONI PER IL DOMANI.

*Light was the past,
It is the present,
It will be our future.*

TODAY WE DESIGN THE SOLUTIONS FOR TOMORROW.

Index

Indice

Su di noi About us	.6
Nuovi prodotti New products	.14
Indice prodotti Products Index	.18
Legenda Legend	.24
OUTDOOR	
.28	Esterni a soffitto e a parete Exterior wall & ceiling
.54	Esterni profili e incassi Exterior surface and recessed profiles
.90	Paletti e proiettori Poles & bollards
.116	Esterni incasso a pavimento Exterior Buried & uplights
INDOOR	
.148	Sistemi lineari Lighting systems
.200	Faretti Spotlights
.222	Downlights
.240	Luci d'ambiente Ambient lights
Accessori Accessories	.242

ILLUMINAZIONE DA 28 ANNI

LIGHTING FROM
28 YEARS





La produzione degli apparecchi d'illuminazione avviene negli stabilimenti di Trezzano Sul Naviglio (Milano) dove si trova anche il centro logistico per la spedizione degli ordini in Italia e all'estero.

Il controllo di qualità viene eseguito su ogni singolo pezzo che viene testato e collaudato prima di lasciare la sede.

CIVIC avvalendosi di un sistema produttivo strutturato e controllato conferma la propria attenzione verso la qualità dei prodotti.

La progettazione ad opera di un reparto interno dedicato, la scelta di fornitori leader nel loro settore e la cura nella realizzazione del prodotto da parte di personale specializzato, contribuiscono alla realizzazione di apparecchi di qualità destinati a durare nel tempo.

Made in Italy

Qualità

The production of the lighting fittings takes place in the factory of Trezzano Sul Naviglio (Milan) where there is also the logistics centre for the shipment of orders in Italy and abroad.

The quality control done on every single piece that is tested and controlled before leaving the premises.

CIVIC makes use of a structured and controlled production system and this confirms its focus quality.

The design done by a dedicated internal department, the choice of leading suppliers in their sector and the care in the production by specialized personnel, contribute to the creation of quality lighting fittings designed to last over time.



100%

FORNITORI ITALIANI

Civic può vantare una produzione interamente fatta in Italia nei propri stabilimenti di Trezzano S/N (Milano).

Le materie prime ed i componenti scelti dal nostro ufficio tecnico sono esclusivamente di alta qualità totalmente Made in Italy.

Questo permette a CIVIC di avere sempre un dialogo diretto con i propri fornitori ed essere così al passo con le ultime novità di ogni settore.

Civic can boast a production entirely made in Italy in its factories in Trezzano S/N (Milan).

The raw materials and components chosen by the technical department are exclusively of high quality and totally Made in Italy.

This allows CIVIC to always have a direct dialogue with its suppliers and be in step with the latest innovations in each sector.



Showroom - Trezzano sul Naviglio, MI

MILANO

ITALY

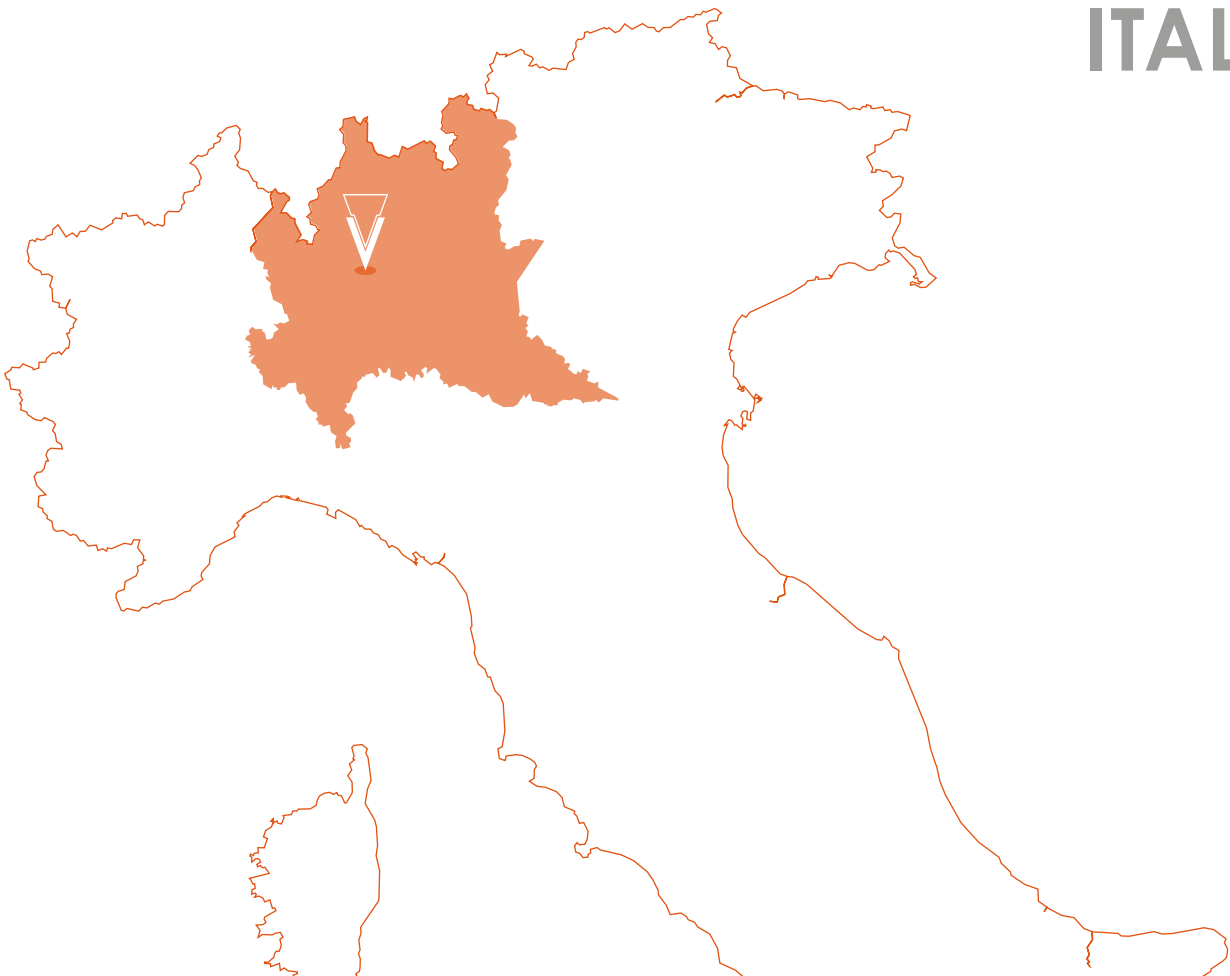



Mario Abbate

Siciliano DOC ma cresciuto a Milano, il Sig. Salvatore Mario Abbate o meglio "il Geometra Abbate", come amavano chiamarlo i suoi collaboratori ed amici, fondò la società CIVIC S.r.l. nel 1994.

Fortemente convinto nell'importanza del servizio al cliente, il Geometra Abbate fu un imprenditore lungimirante dal punto di vista tecnico ed estetico: fu il primo in Italia a creare i sistemi lineari dalle forme più svariate.

Capace di comprendere le esigenze del mercato creò due sistemi in auge ancora oggi: il ROTONDO e L'OVALE, tra i modelli ancora più copiati al mondo.

Sicilian DOC but raised in Milan, Mr. Salvatore Mario Abbate or better "Il Geometra Abbate", as his collaborators and friends loved to call him, founded the company CIVIC S.r.l. in 1994.

Strongly convinced in the importance of the service to his customers, "il Geometra Abbate" was a forward-looking entrepreneur from the technical and aesthetic point of view: he was the first in Italy to create linear systems with different shapes.

Able to understand the needs of the market, he created two systems still in vogue today: the ROUND and OVAL, among the most copied models in the world.

DALLA TRADIZIONE FROM TRADITION





ALL'INNOVAZIONE TO INNOVATION

La capacità di seguire l'andamento del mercato e le mutevoli esigenze dei consumatori, ha permesso a CIVIC di adattarsi senza alcuna difficoltà all'arrivo delle nuove sorgenti luminose a LED. Dapprima modelli già esistenti vennero adattati al nuovo modo di illuminare e successivamente l'ufficio tecnico, arricchitosi intanto di professionisti sempre all'avanguardia, ha saputo creare nuovi modelli nati con e per le sorgenti a LED.

Il costante impegno anche dei figli in azienda ha permesso a CIVIC di sapersi sempre rinnovare e di restare al passo con i tempi, diventato quello che è oggi ovvero una realtà in grado di produrre apparecchi d'illuminazione tecnica e di design per esterni ed interni sempre al passo con i tempi.

The ability to follow the trend of the market and the changing needs of the consumers, have allowed CIVIC to adapt without any difficulty to the arrival of new LED light sources. At first, existing models were redesigned to the new way of lighting and then the technical office, enriched in the meantime with specialised professionals, has been able to create new models born with and for the LED sources.

The constant commitment also of the sons in the company, has given CIVIC the capability to always renew itself and keep up with the times becoming the reality that it is today: capable to produce technical and design lighting fittings for outdoor and indoor always original and fashionable.



LIMIT

Siamo orgogliosi di produrre in Italia e di poter esportare la bellezza e la qualità del Made in Italy nel mondo.

L'anno che si è concluso, ha visto le nostre esportazioni raggiungere svariati luoghi del globo, arrivando ad oltre 28 diversi paesi.

We are proud to produce in Italy and to be able to export the beauty and quality of Made in Italy around the world.

The last year has seen our exports reach various places around the globe, reaching over 28 different countries.

**Everywhere
you need**

Custom products made with you

Una delle chiavi del successo di CIVIC è stata la capacità e la voglia di accontentare sempre i propri clienti creando così soluzioni in grado di adattarsi agli scenari più diversi. Negli anni, CIVIC è stata definita come la società del "Tailor Made" per la sua capacità quasi di cucire, sulle esigenze del cliente, apparecchi d'illuminazione adatti ai suoi progetti.

Custom Made per CIVIC significa: colori, lunghezze, potenze, temperature di colore ed altre caratteristiche realizzate su richiesta, perché per CIVIC il cliente è sempre al primo posto.

One of the keys to the success of CIVIC has been the ability and desire to always satisfy its customers creating solutions that can adapt to the most diverse scenarios. Over the years, CIVIC has been often called as the company of the "Tailor Made" for its ability almost to sew, on the needs of the customer, lighting fixtures suitable for his projects.

Custom Made for CIVIC means: colours, lengths, powers, colour temperatures and other features made on request, because for CIVIC the customer is always in first place.

WORLDWIDE

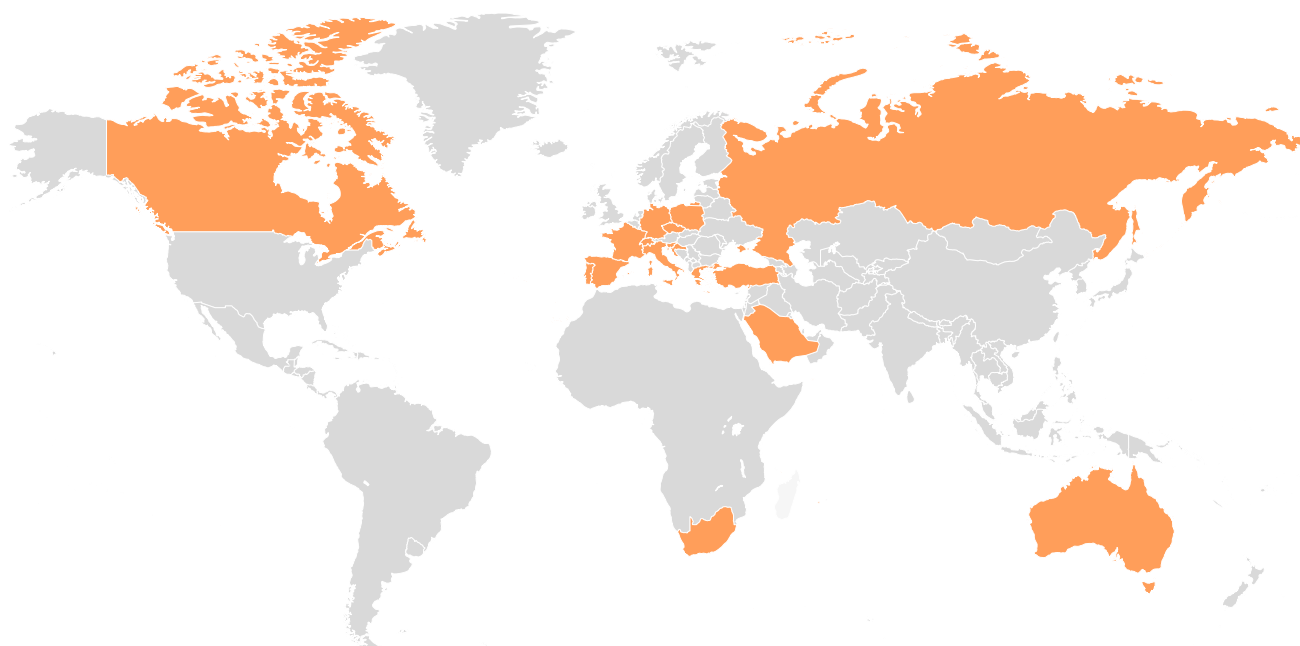

from INSIDE

Minu Square

Pag 150

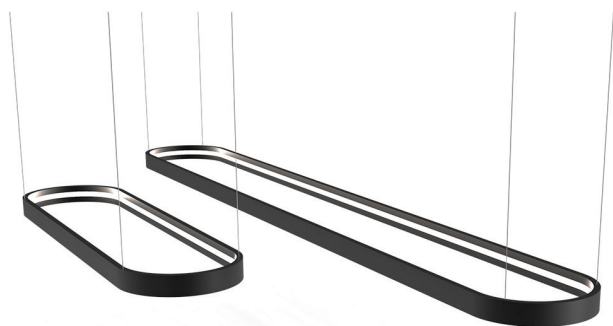
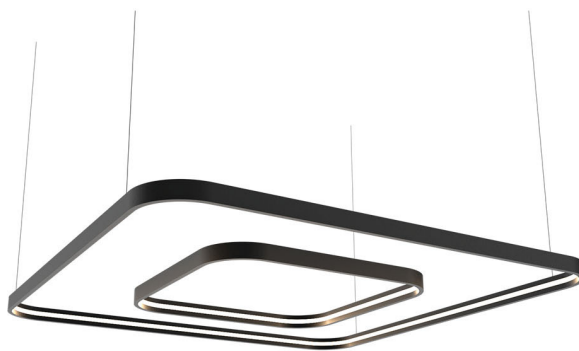

Minu Lap

Pag 150



Cocktail UGR

Pag 174

T-Uni UGR

Pag 180



NEW

NEW



Mini Orfeo Pro
Pag 92



Tebe
Pag 108



Raggio Up
Pag 140

Ios
Pag 44



Net 50
Pag 62

Raggio Spot
Pag 104



to
OUTSIDE

Indice

PRODOTTI

PRODUCTS

Index

ESTERNI

VERSO L'OUTDOOR TO OUTDOOR

Le mutate esigenze sociali che accomunano tutti noi hanno reso gli spazi esterni particolarmente importanti e graditi. Per questo motivo CIVIC ha deciso di sfruttare la sua esperienza nel settore dell'outdoor per migliorare i modelli esistenti e creare nuove forme per l'illuminazione di facciate, giardini, viali e tutti gli spazi esterni dove le esigenze illuminotecniche si sposano con il design e l'innovazione.

The changing social needs that we all have in common have made outdoor spaces particularly important and appreciated. This is the reason why CIVIC has decided to take advantage of its experience in the outdoor sector to improve the existing models and create new forms for facade lighting, gardens, avenues and all outdoor areas where lighting needs are combined with design and innovation.



A SOFFITTO E A PARETE SURFACE PROFILES



— APOLLO — 30



— MINI APOLLO — 30

APOLLO
SERIES



— MINI ORFEO — 36



— LUXA — 40



— IOS — 44



— SOLE — 48



— CARD — 48

SEGNAPASSO
SERIES

OUTDOOR

ESTERNI

PROFILI



— ALU PROOF 56

NET
SERIES



— NET 16 62



— NET 50 62



— NET 70 62

CABRIO
SERIES



— CABRIO 70



— CABRIO RECESSED 70



— RAISE 80



— SPIDER RECESSED 84

PALETTI & PROIETTORI POLES & BOLLARDS



— MINI ORFEO PRO 92



— NIK 96



— TITAN 100



RAGGIO SPOT 104



TEBA 108



MINI APOLLO PALETTO 112

INCASSI A PAVIMENTO BURIED & UPLIGHTS



ZEUS 118



PERSEO 118



ERA 118



DIANA 118



ZANTE 128



ERIC 128



DAVID 128



BOSS 136



RAGGIO SIDE 140



RAGGIO UP 140

CARRABILI
DRIVEABLE SERIES

CALPESTABILI
WALKABLE SERIES

RAGGIO
SERIES

OUTDOOR

SISTEMI LINEARI LIGHTING SYSTEMS



MINU SERIES



MINU DIFFUSER 150



MINU-R 150



MINU SQUARE 150



MINU LAP 150

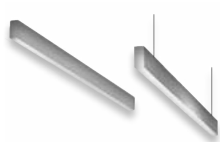

SHADOW 162

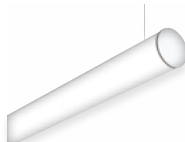

ULISSE 166



ROUND 170

COCKTAIL SERIES



COCKTAIL DIFFUSER 174



COCKTAIL UGR 174

T-UNI SERIES



T-UNI 180



T-UNI LENS 180



T-UNI UGR 180



T-UNI RECESSED 180



T-UNI RECESSED FRAMELESS 180

T3 SERIES



T-3 194



T-3 RECESSED FRAMELESS 194



FARETTI SPOTLIGHTS



— **DIVA IN** 202



— **DIVA Plus** 202



— **DIVA BASE** 202



— **BINARI TRACKS** 210
230V



— **DONNA** 212
SMALL & LARGE



— **DONNA** 212
INFINITY



— **BINARI TRACKS** 220
48V

DIVA
SERIES

DONNA
SERIES



DOWNLIGHTS



— **FLUX** 224



— **MODO** 228



— **AIR** 236



LUCI D'AMBIENTE AMBIENT LIGHTS



— **F 44** 242



— **F 55** 242

INDOOR

ACCESSORI

PROFILI PER STRIP LED TAPELIGHT PROFILES



ZERO SURFACE 244



BASE 1 245



BASE 3 246



GRADO 247

DRIVERS



249

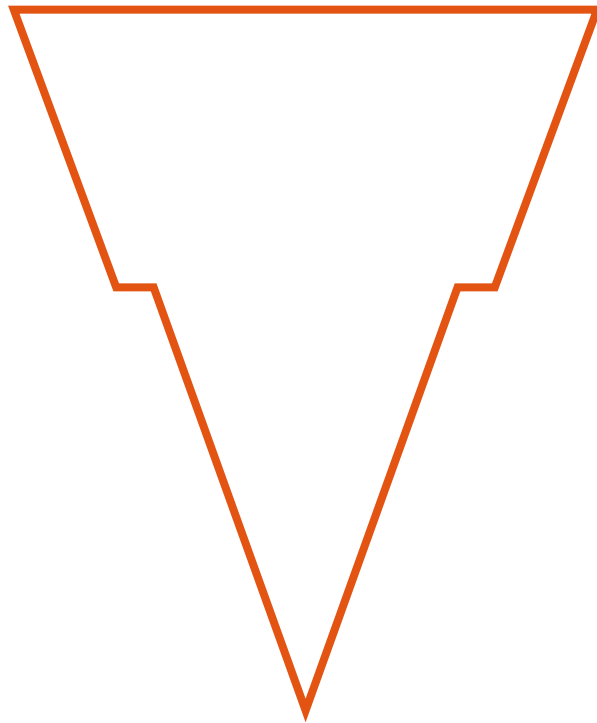

CE	IP65
LED	RG1
CRI 80	Driver incl.
L80 B10	50000H
	Mac Adam 3



NOME PRODOTTO
PRODUCT NAME

CABRIO

COLORE
COLOUR

Z.
COLOR

- anodizzato/anodised -05
- antracite/anthracite -06
- grigio chiaro opaco/clear matt grey -37
- custom -99

DISEGNO TECNICO
TECHNICAL DRAWING

15°
1

30°
2

10x45°
3

CR180
5

Y.
4000K
7

3000K
8

DIM.
1-10V
A1

AGGIUNTE AL
CODICE BASE
ADD TO BASE CODE

CODICE BASE
BASE CODE

DALI
A2

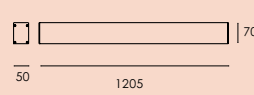
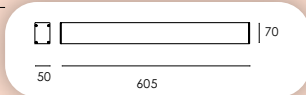

CODICE / CODE L.MM W LM FASCIO / BEAM

JEC.5916.0 5 Y. Z	605	12.5W/230V LED	1585/1502	diffuso/diffuse 120°
JEC.5921.1 5 Y. Z	605	14x1.2W/230V LED	1502/1295	stretto/narrow 15°
JEC.5921.2 5 Y. Z	605	14x1.2W/230V LED	1502/1295	largo/wide 30°
JEC.5921.3 5 Y. Z	605	14x1.2W/230V LED	1502/1295	ellittico/elliptical 10x45°
JEC.5921.4 5 Y. Z	605	14x1.2W/230V LED	1502/1295	ellittico/elliptical 11x30°
JEC.5918.0 5 Y. Z	1205	25W/230V LED	3170/3004	diffuso/diffuse 120°
JEC.5923.1 5 Y. Z	1205	28x1.2W/230V LED	3016/2590	stretto/narrow 15°
JEC.5923.2 5 Y. Z	1205	28x1.2W/230V LED	3016/2590	largo/wide 30°
JEC.5923.3 5 Y. Z	1205	28x1.2W/230V LED	3016/2590	ellittico/elliptical 10x45°
JEC.5923.4 5 Y. Z	1205	28x1.2W/230V LED	3016/2590	ellittico/elliptical 11x30°

ACCESSORI / ACCESSORIES



JEC.AP
Attacchi a parete (coppia).
Wall mount (pair).



AAA.CN3
Connettore IP68, 3vie.
IP68 waterproof connector, 3way.



JEC.APR
Ganci di fissaggio regolabili (coppia).
Fixing adjustable hook (pair).



AAA.CN4
Connettore IP68, 4vie.
IP68 waterproof connector, 4way.

COMPOSIZIONE DEL CODICE COMPLETO

Identifica il codice base e poi scegli D, X, Y, Z, A.

COMPOSE THE CODE FORMAT

Identify base code and choose D, X, Y, Z, A.

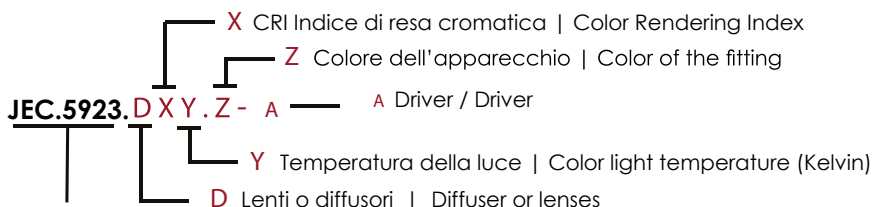





















Codice base che identifica la famiglia del prodotto e le varie sottocategorie

Base code identifies the family product and lengths

ESEMPIO | EXAMPLE

Famiglia Family	Corpo Body	Lenti Diffusori Diffuser Lenses	CRI	Kelvin	Colour	Driver
JEC	5923	3	5	7	.05	A2
Cabrio	L.1205mm	10x45°	CR180	4000K	Anodizzato Anodized	DALI Driver

LEGENDA

Simbolo	Descrizione	Description	Description
	Marcatura CE contraddistingue la conformità del prodotto ai requisiti di sicurezza previsti per l'immissione sul mercato dell'unione europea.	CE Mark It distinguishes the product conformity to the safety requirements that are necessary for the introduction of the product on the european market.	Marque CE elle distingue la conformité du produit aux requises d'assurance qui sont prévus par l'introduction du produit sur le marché de l'union européenne.
	Classe 1 Apparecchio che necessita di messa a terra. Sono ad essa collegate tutte le parti che potrebbero essere toccate e in caso di difetto causare una scossa elettrica.	Class 1 Luminaire that needs earth connection. To the earth are connected all the parts that might be touched and in case of defect cause electrical shock.	Classe 1 Luminaire qui doit être relié à la terre. La terre doit être reliée à toutes les parties qui pourraient être touchées et en cas de défaut provoqué par un choc électrique.
	Classe 2 Apparecchio che non necessita di messa a terra. Tutte le parti metalliche che potrebbero causare una scossa elettrica in caso di difetto non possono essere toccate.	Class 2 Luminaire that doesn't need earth connection. All the metal parts that might cause electrical shock in case of defect cannot be touched.	Classe 2 Luminaire que nécessite pas d'être relié à la terre. Toutes les parties métalliques qui pourraient causer un choc électrique ne peuvent pas être touchées.
	Classe 3 Apparecchio per uso a bassa tensione (non superiore a 24V) con alimentazione mediante trasformatore di sicurezza.	Class 3 Luminaire for low voltage use (not exceeding 24V) supplied with a safety transformer.	Classe 3 Luminaire bas voltage (n'excédant pas 24V) alimentés par un transformateur de sécurité.
IP	Grado di protezione dell'apparecchio contro l'ingresso di solidi e liquidi: la prima cifra identifica il grado di protezione contro l'ingresso di corpi solidi, la seconda quello contro l'ingresso di liquidi.	Protection degree of the fitting against the penetration of solids and liquids: the first number identifies the protection degree against the entry of solid bodies, the second one the protection degree against the entry of liquid.	Degré de protection offert par les appareils contre la pénétration des solides et liquides: le premier chiffre indique la protection contre la pénétration des corps solides, le deuxième chiffre pour les liquides.
IP1X	IP1X - Protetto contro la penetrazione di corpi solidi di dimensioni superiori a 50 mm. IP2X - Protetto contro la penetrazione di corpi solidi di dimensioni superiori a 12 mm. IP3X - Protetto contro la penetrazione di corpi solidi di dimensioni superiori a 2,5 mm. IP4X - Protetto contro la penetrazione di corpi solidi di dimensioni superiori a 1 mm. IP5X - Protetto contro la penetrazione della polvere. IP6X - Protetto completamente contro la penetrazione della polvere.	IP1X - Protected against the entry of solid bodies with dimensions of more than 50 mm. IP2X - Protected against the entry of solid bodies with dimensions of more than 12 mm. IP3X - Protected against the entry of solid bodies with dimensions of more than 2,5 mm. IP4X - Protected against the entry of solid bodies with dimensions of more than 1 mm. IP5X - Protected against entry of dust. IP6X - Completely protected against entry of dust.	IP1X - Protégé contre la pénétration de corps solides supérieurs à 50 mm. IP2X - Protégé contre la pénétration de corps solides supérieurs à 12 mm. IP3X - Protégé contre la pénétration de corps solides supérieurs à 2,5 mm. IP4X - Protégé contre la pénétration de corps solides supérieurs à 1 mm. IP5X - Protégé contre la pénétration de la poussière. IP6X - Totalement protégé contre la pénétration de la poussière.
IPX1	IPX1 - Protetto contro le cadute verticali di gocce d'acqua. IPX2 - Protetto contro le cadute dell'acqua con inclinazione massima di 15°. IPX3 - Protetto contro la pioggia. IPX4 - Protetto contro gli spruzzi. IPX5 - Protetto contro i getti d'acqua. IPX6 - Protetto contro le ondate. IPX7 - Protetto all'immersione temporanea. IPX8 - Protetto alla sommersione prolungata.	IPX1 - Protected against the vertical falling of water drops. IPX2 - Protected against the falling of water with maximum inclination of 15°. IPX3 - Protected against rain. IPX4 - Protected against sprinklings. IPX5 - Protected against water jets. IPX6 - Protected against waves. IPX7 - Protected against temporary immersion. IPX8 - Protected against prolonged immersion.	IPX1 - Protégé contre les chutes verticales de gouttes d'eau. IPX2 - Protégé contre les chutes d'eau pour une inclinaison maximale de 15°. IPX3 - Protégé contre la pluie. IPX4 - Protégé contre les projections d'eau. IPX5 - Protégé contre les jets d'eau. IPX6 - Protégé contre les paquets de mer. IPX7 - Protégé contre les effets de l'immersion. IPX8 - Protégé contre les effets de l'immersion prolongée.
	Angolo di basculamento.	Adjustment angle.	Orientabile verticalmente.
	Angolo di rotazione.	Rotation angle.	Orientabile orizzontalmente.
	Distanza minima dall'oggetto illuminato.	Minimum distance from the enlightened object.	Espacement minimum à l'objet illuminé.
Codici colore	Colori	Colours	Couleurs
 02	bianco RAL9010	white RAL9010	blanc RAL9010
 03	nero RAL9005	black RAL9005	noir RAL9005
 05	anodizzato naturale	natural anodized	anodisé naturel
 06	grigio antracite	anthracite grey	gris anthracite
 07	grigio chiaro metallizzato RAL9006	metallic grey RAL9006	gris métallisé RAL9006
 11	alluminio spazzolato	brushed aluminium	aluminium brossé
 15	alluminio naturale	natural aluminium	aluminium naturel
 28	grigio chiaro RAL7035	clear grey RAL7035	gris clair RAL7035
 32	bianco raggrinzante	rough white	blanc plissement
 33	nero raggrinzante	rough black	noir plissement
 37	grigio chiaro opaco	clear matte grey	gris clair opaque
 39	corten	corten	corten
 50	grigio opaco metallizzato	metallic grey	gris opaque métallisé
 99	colore su richiesta	custom color	couleur personnalisée

OUTDOOR ESTERNI
STERNI Outdoor
OUTDOOR ESTERNI
STERNI OUTDO
STERNI **OUTDO**
OUTDOOR ESTERNI
STERNI Outdoor
STERNI OUTDO
OUTDOOR ESTERNI

NI OUTDOOR ES
or ESTERNI Outdo
RNI OUTDOOR
OR ESTERNI Ou
OR Outdoor ES
RNI ESTERNI Ou
or OUTDOOR
OR Outdoor ES
RNI ESTERNI Ou



A SOFFITTO E PARE

Exterior wall & ceiling



TE

Outdoor

A P O L L O

Apollo Mini Apollo

Apollo è una famiglia di prodotti che risulta ideale per l'illuminazione di facciate, percorsi in esterni e luoghi in cui sia richiesto un elevato grado di protezione. È disponibile in diverse dimensioni ed utilizzi in versione a luce diretta e diretta/indiretta. La sua forma essenziale lo rende adatto alle ambientazioni più diverse, dalle domestiche ai grandi spazi architettonici.

Apollo is a family of products ideal to enlighten facades, external pathways and environments where an high IP rate is needed. It available in different versions sizes and for different uses. It's essential shape makes it adapt to many different environments, from domestic ones to the big architectural buildings.



Scopri anche / Look at:
Mini Apollo paletto
pag 112
Paletti e proiettori
Poles and Bollards







APOLLO

La struttura è in fusione di alluminio verniciato a polveri epossipoliestere. Vetro temperato trasparente/sabbiato. LED: tono luce bianco 4000K o 3000K, emissione diretta e diretta/indiretta, simmetrica o asimmetrica.

Potenze a partire da 3000lm luce diretta asimmetrica fino a 5400lm luce diretta/indiretta.

The structure is in die cast aluminum powder coated. LED: 4000K or 3000K white light tone, emission direct and direct / indirect, symmetric or asymmetric.

Powers from 3000lm, with direct light asymmetrical, up to 5400lm with direct/indirect light.



MINI APOLLO

La struttura è in fusione di alluminio verniciato a polveri epossipoliestere. Vetro temperato trasparente/sabbiato. LED: tono luce bianco 4000K o 3000K, emissione diretta e diretta/indiretta, con lenti a fascio stretto e largo, con riflettore a fascio largo o luce diffusa. Potenze a partire da 4,8W/456lm luce diretta fino a 9,6W/1008lm luce diretta/indiretta.

The structure is in die cast aluminum powder coated. LED: 4000K or 3000K white light tone, emission direct and direct / indirect, with narrow or wide beam lenses, wide beam reflector or diffuse beam. Powers from 4,8W/456lm with direct light up to 9,6W/1008lm direct/indirect light.

CE	IP65
CRI 80/90	RG1
LED	Driver incl.
L80 B10	50000H
⏚	Mac Adam 3



A P O L L O

D.
TRASPARENTE
CLEAR
0

SABBIATO
SANDED
1

X.
CRI80
5

CRI90
6

Y.
4000K
7

3000K
8

Z.
COLOR

- antracite/anthracite -06
- bianco ragg./rough white -32
- nero ragg. / rough black -33
- grigio chiaro/clear grey -37
- custom -99

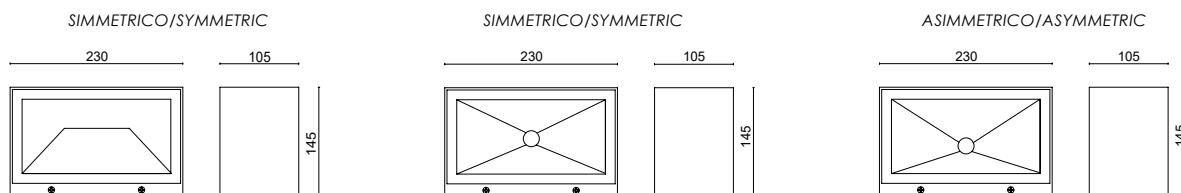

CODICE / CODE	W	LM	EMISSIONE / EMISSION
SIMMETRICO/ SYMMETRIC			
MTA.5410. D X Y. Z	12.5W/230V LED	1780/1700	diretta/direct
MTA.5411. D X Y. Z	25W/230V LED	3560/3400	diretta+indiretta/direct+indirect
SIMMETRICO/ SYMMETRIC			
MTA.5408. 0 X Y. Z	17W/230V LED	2700/2550	diretta/direct
MTA.5409. 0 X Y. Z	34W/230V LED	5400/5100	diretta+indiretta/direct+indirect
ASIMMETRICO/ ASYMMETRIC			
MTA.5404. 1 X Y. Z	26.3W/230V LED	3000/3000	diretta/direct



CE	IP65
CRI 80/90	RG1
LED	Driver incl.
L80 B10	Mac Adam 3
50000H	⏚

- 06- antracite/anthracite
- 32- bianco ragg./rough white
- 33- nero ragg. / rough black
- 37- grigio chiaro/clear grey
- 99- custom

Z.
COLOR

MINI APOLLO

MINI APOLLO LENTI/LENSES

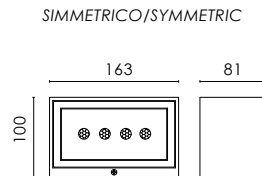

MINI APOLLO RIFLETTORE/REFLECTOR

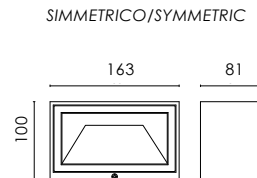

CODICE / CODE

W

LM

EMISSIONE / EMISSION

LENTI/LENSES

MTA.5416. D X Y. Z	4.8W/230V LED	504/456	diretta/direct
MTA.5417. D X Y. Z	9.6W/230V LED	1008/912	diretta+indiretta/direct+indirect

RIFLETTORE/REFLECTOR

MTA.5416. 2 X Y. Z	9,6W/230V LED	850/800	diretta/direct
MTA.5417. 2 X Y. Z	9,6W/230V LED	850/800	diretta+indiretta/direct+indirect

D.
LARGO
LARGE
60° 1

STRETTO
NARROW
15° 3

STRETTO
NARROW
+
LARGO
LARGE 4

X.
CRI80
5

CRI90
6

Y.
4000K
7

3000K
8

MINI ORFEO



Faretto quadrato dal design essenziale disponibile in molteplici varianti. Pensato per l'esterno per illuminare porticati, scale balconate e terrazzi può essere utilizzato anche in interni per illuminare ingressi, halls e corridoi.

Square spotlight with an essential design available in many variations. Designed for outdoors to illuminate porches, stairs, balconies and terraces, it can also be used indoors to illuminate entrances, halls and corridors.



MINI ORFEO

Faretto da soffitto realizzato in alluminio pressofuso e diffusore in vetro temperato trasparente o satinato ed è disponibile in diversi colori. Dimensioni: 155x155 mm.

The body is made of die-cast aluminum and tempered transparent or satined glass diffuser and it is available in different colors. Dimensions : 155x155mm.

Scopri anche / look at:

Mini Orfeo Pro

pag. 92

Paletti & proiettori

Poles & bollards



CE	IP65
LED	RG1
CRI 80/90	Driver incl.
L80 B10	50000H
⏚	Mac Adam 3



MINI ORFEO

X.
CRI80
5

CRI90
6

Y.
4000K
7

3000K
8

Z.
COLOR

- antracite/anthracite -06
- bianco ragg./rough white -32
- nero ragg. / rough black -33
- grigio chiaro/clear grey -37
- custom -99

MODELLO 1/ MODEL 1

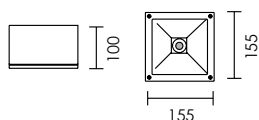

MODELLO 2/ MODEL 2

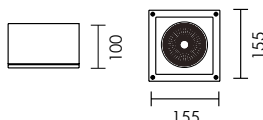

MODELLO 3/ MODEL 3

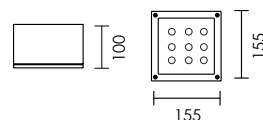

CODICE / CODE	W	LM	FASCIO / BEAM	DIFFUSORE/ DIFFUSER
MODELLO 1/ MODEL 1				
MTP.5411. 0 X Y. Z	12,5W/230V LED	2650/2540	60°	trasparente/transparent
MTP.5411. 1 X Y. Z	12,5W/230V LED	2650/2540	60°	satinato/satined
MODELLO 2/ MODEL 2				
MTP.5433. 1 X Y. Z	12,5W/230V LED	2650/2540	13°	trasparente/transparent
MTP.5433. 2 X Y. Z	12,5W/230V LED	2650/2540	20°	trasparente/transparent
MTP.5433. 3 X Y. Z	12,5W/230V LED	2650/2540	38°	trasparente/transparent
MODELLO 3/ MODEL 3				
MTP.5444. 1 X Y. Z	18W/230V LED	1880/1750	15°	trasparente/transparent
MTP.5444. 2 X Y. Z	18W/230V LED	1880/1750	25°	trasparente/transparent
MTP.5444. 3 X Y. Z	18W/230V LED	1880/1750	38°	trasparente/transparent

ACCESSORI / ACCESSORIES



MTP.AG
Schermo antiabbagliamento.
Anti-glare screen.



LUXA LUXA LUXA LUXA MINI MINI MINI MINI



Serie di apparecchi per esterni, disponibili nella versione da parete e da plafone. Per il loro design lineare risultano particolarmente adatte ad ambienti di tipo moderno, sia in ambito privato che commerciale. Luxa e Mini Luxa arredano e illuminano adeguatamente verande, balconi, terrazzi ma anche scale e pareti di strutture ricettive, alberghi e piscine.

Series of outdoor luminaires, available in the wall and ceiling version. Due to their linear design they are particularly suitable for modern environments, both in private and commercial environments. Luxa and Mini Luxa adequately furnish and illuminate verandas, balconies, terraces but also stairs and walls of accommodation facilities, hotels and swimming pools.

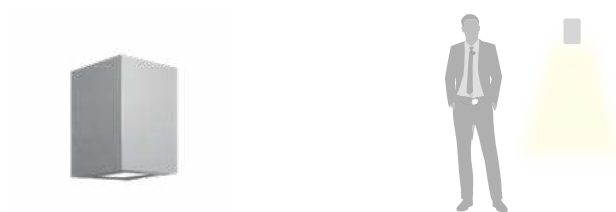

LUXA

Serie di apparecchi per esterni . Disponibile nelle versioni parete e soffitto. Struttura in estruso di alluminio e viterie in acciaio inox. Driver incluso.

Serie of outdoor lighting fittings. Available as wall and ceiling version. Structure in aluminum. Stainless steel screws. Driver included.



MINI LUXA

Serie di apparecchi per esterni . Disponibile nella versione a parete. Struttura in estruso di alluminio e viterie in acciaio inox. Driver incluso.

Serie of outdoor lighting fittings. Available as wall and ceiling version. Structure in aluminum. Stainless steel screws. Driver included.

CE	IP65
LED	RG1
CRI 80/90	Driver incl.
L80 B10	50000H
⏚	Mac Adam 3



LUXA

X.
CRI80
5

CRI90
6

A SOFFITTO/ CEILING

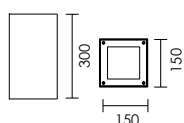

A PARETE/ WALL

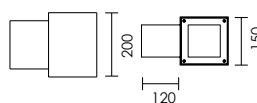

Z.
COLOR

- antracite/anthracite -06
- bianco ragg./rough white -32
- nero ragg. / rough black -33
- grigio chiaro/clear grey -37
- custom -99

CODICE / CODE	W	K	LM	EMISSIONE / EMISSION
A SOFFITTO/ CEILING				
MTX.5476. 1 X 7. Z	17W/230V LED	4000K	2700	diretta/direct 45°
MTX.5476. 1 X 8. Z	17W/230V LED	3000K	2550	diretta/direct 45°
A PARETE/ WALL				
MTX.5479. 1 X 7. Z	34W/230V LED	4000K	5400	dir+indir 45°- 45°
MTX.5479. 1 X 8. Z	34W/230V LED	3000K	5100	dir+indir 45°- 45°
MTX.5479. 2 X 7. Z	34W/230V LED	4000K	5400	dir+indir 45°- 10°
MTX.5479. 2 X 8. Z	34W/230V LED	3000K	5100	dir+indir 45°- 10°



CE	IP65
LED	RG1
CRI 80/90	Driver incl.
L80 B10	Mac Adam 3
50000H	⏚

- **06**- antracite/anthracite
- **32**- bianco ragg./rough white
- **33**- nero ragg. / rough black
- **37**- grigio chiaro/clear grey
- **99**- custom

Z.
COLOR

MINI LUXA

A PARETE/ WALL

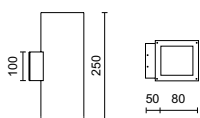

A PARETE/ WALL GU10

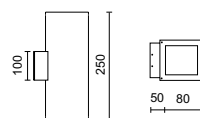

X.
CRI80
5
CRI90
6

CODICE / CODE

W

K

EMISSIONE / EMISSION

A PARETE, WALL

MTX.5475. 1 X 7. Z 6x1,2W/230V LED 4000K
MTX.5475. 1 X 8. Z 6x1,2W/230V LED 3000K

dir+indir 20°- 20°
 dir+indir 20°- 20°

A PARETE, WALL

GU10

MTX.35BGUW. Z 2x50W/230V GU10 lamp. esclusa/lamp excluded dir+indir

LOS



Con los nasce una nuova linea di downlight da esterno CIVIC. Interamente in acciaio INOX abbina le sue doti di resistenza agli agenti atmosferici a performance illuminotecniche ed estetiche di livello elevato.

los is the first of a new line of outdoor CIVIC downlights. Entirely made in stainless steel, it combines resistance to atmospheric agents with high-level lighting and aesthetic performance.



IOS



Corpo e anello di chiusura in acciaio inox AISI 304. Grado di protezione IP67. Schermo di protezione in vetro trasparente temperato di spessore 10mm con resistenza meccanica IK 10. Guarnizione in gomma al silicone. Ottica fissa con lente. Equipaggiato con LED di colore bianco 4000K o 3000K potenza 9W o con portalampada GU10. Fornito completo di driver integrato nella struttura e di cavo di collegamento H05RN-F 3x1mm².

Structure and closing ring made of AISI 304 stainless steel. IP67 protection degree. Protection shield made of transparent tempered glass with 10mm thickness and IK 10 shock resistance. Silicone rubber gasket. Fixed or adjustable lens optic. Equipped with one LED in 4000K or 3000K color temperature power 9W or with GU10 lampholder. Supplied with built-in driver and H05RN-F 3x1mm² connecting cable.

CE	IP67
LED	RG1
CRI 80/90	Driver incl.
L80 B10	Mac Adam 3
50000H	

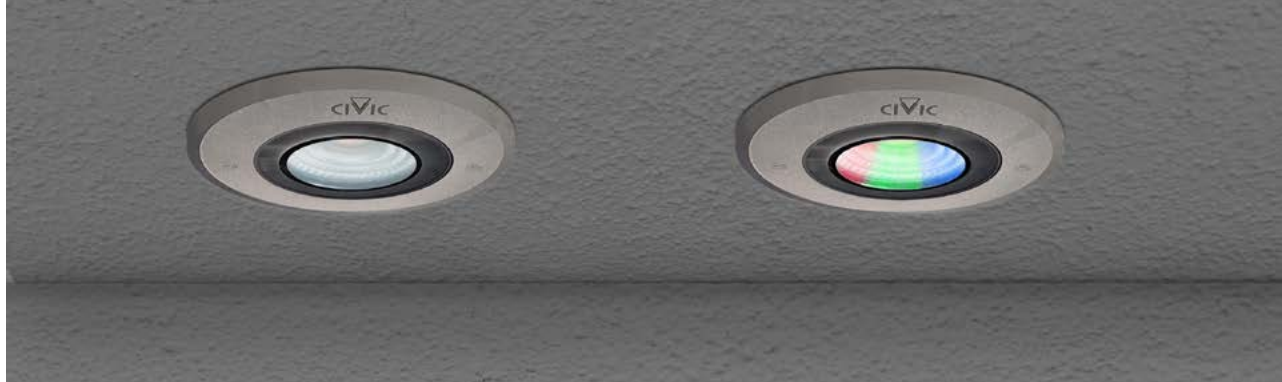

IOS

D.
OPTIC
36°
1

OPTIC
24°
2

OPTIC
12°
3

X.
CRI80
5

CRI90
6

Y.
4000K
7

3000K
8

2700K
9

FISSO / FIXED

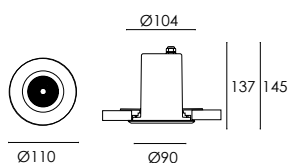

FISSO RGB / FIXED RGB

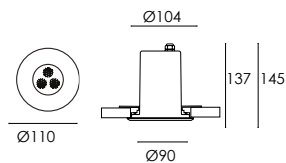

CODICE / CODE	L.MM	W	LM	DRIVER
FISSO / FIXED				
IOS.6602.D X Y	Ø110	9W/230V LED	890/840/770	built-in/incorporato
IOS.35FGU	Ø110	200W/230V GU10 lamp. esclusa/lamp excluded		
FISSO RGB / FIXED RGB				
IOS.6602.299	Ø110	6W/24V LED	420	FASCIO/BEAM:25° excluded/escluso

ACCESSORI / ACCESSORIES



DEO.FG
Vetro sabbato.
Sanded glass.



DEO.MS
Master DEO RGB.

DEO.SL
Slave DEO RGB.



SEGNAPASSO PATH MARKERS

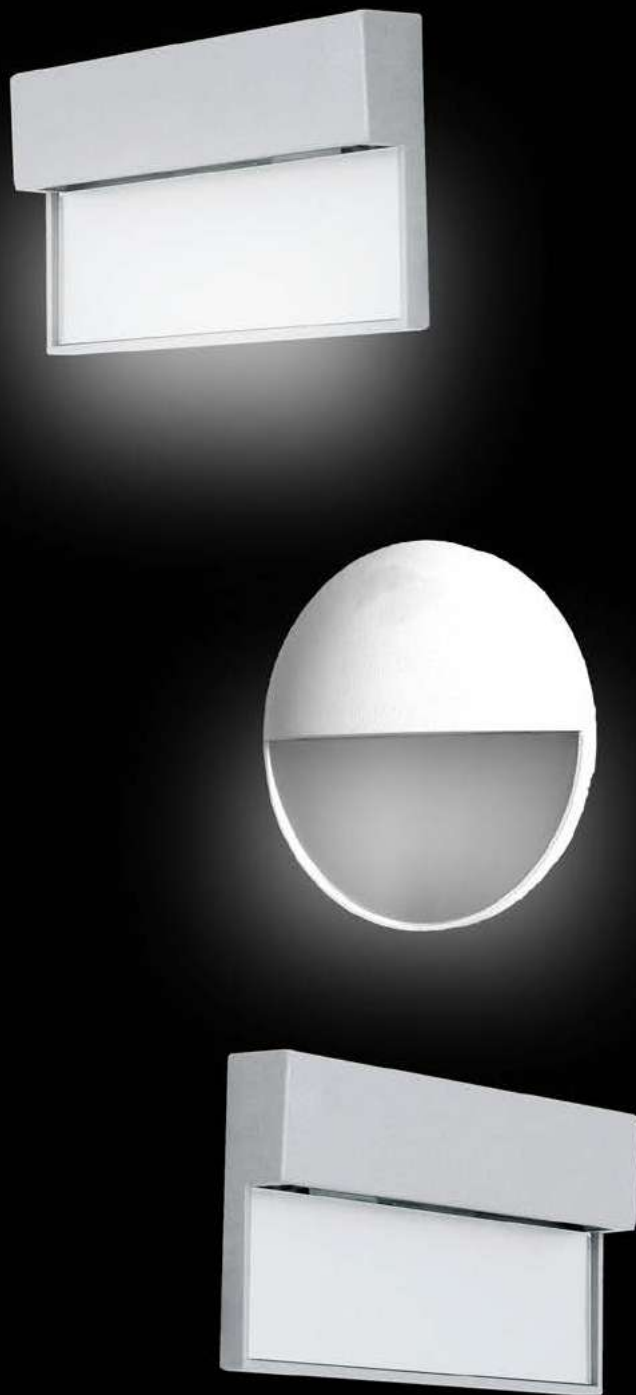

Segnapassi da esterno da parete dalle forme minimali dal design elegante e moderno. Disponibili in 2 versioni, rotonda e rettangolare con un fascio luminoso radente e discreto risultano essere l'ideale per illuminare scalinate, ingressi e viali di accesso.

Outdoor wall step markers with minimal shape and modern design. Available in two different versions, round and rectangular with grazing light beam are ideal staircases, entrances and access paths lighting.

Card

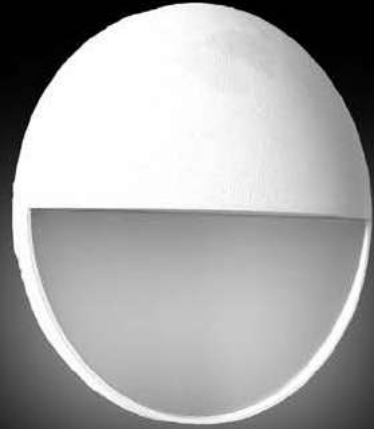

Sole

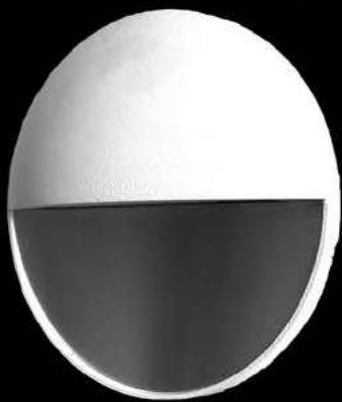





CARD

Struttura in fusione di alluminio verniciato a polveri epossipoliestere. LED tono luce bianco 4000K o 3000K, emissione diretta asimmetrica. Potenza 2.5W 24V. Grado di protezione IP65. Possono essere fissati direttamente su scatole da incasso di misure standard. Driver remoto escluso.

Structure in die cast aluminum, epoxy polyester powder coating. LED white light tone 4000K or 3000K, direct asymmetric emission. Power 2.5W - 24V. IP65 protection degree. Card can be fixed directly on standard 108x74mm recessed box. Driver remote excluded.



SOLE

La struttura è in fusione di alluminio verniciato a polveri epossipoliestere. LED tono luce bianco 4000K o 3000K, emissione diretta asimmetrica. Potenza 2.5W 24V. Grado di protezione IP65. Possono essere fissati direttamente su scatole da incasso di misure standard. Driver remoto escluso.

Structure in die cast aluminum, epoxy polyester powder coating. LED white light tone 4000K or 3000K, direct asymmetric emission. Power 2.5W - 24V. IP65 protection degree. Sole can be fixed directly on standard 108x74mm recessed box. Driver remote excluded.

CE	IP65
LED	RG1
CRI 90	Mac Adam 3
L80 B10	50000H
	



CARD



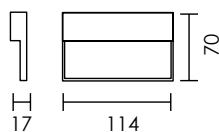

CRI90
6

4000K
7

3000K
8



Z.
COLOR

- antracite/anthracite -06 
- bianco ragg./rough white -32 
- nero ragg. / rough black -33 
- grigio chiaro/clear grey -37 
- custom -99 

CODICE / CODE	L.MM	W	K	LM	DRIVER
MTS.5430. 0 6 7. Z	114x79	2.5W/24V LED	4000K	200	driver escluso/ driver excluded
MTS.5430. 0 6 8. Z	114x79	2.5W/24V LED	3000K	200	driver escluso/ driver excluded

ACCESSORI / ACCESSORIES



MTS.5428.001
Scatola incasso per Card.
Recessed box for Card.



AAA.TRSL14
LED Driver IP20 8W 24V.



AAA.TRSL15
LED Driver IP65 10W 24V.



CE	IP65
LED	RG1
CRI 90	Mac Adam 3
L80 B10	50000H

SOLE

- 06-** antracite/anthracite
- 32-** bianco ragg./rough white
- 33-** nero ragg. / rough black
- 37-** grigio chiaro/clear grey
- 99-** custom

Z.
COLOR

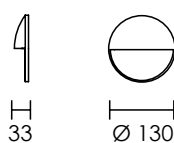

CRI90
6

4000K
7

3000K
8

CODICE / CODE	D.MM	W	K	LM	DRIVER
MTS.5428. 0 6 7. Z	130	2.5W/24V LED	4000K	200	driver escluso/ driver excluded
MTS.5428. 0 6 8. Z	130	2.5W/24V LED	3000K	200	driver escluso/ driver excluded

ACCESSORI / ACCESSORIES



MTS.5428.001
Scatola incasso per Sole.
Recessed box for Sole.



AAA.TRSL14
LED Driver IP20 8W 24V.



AAA.TRSL15
LED Driver IP65 10W 24V.



PROFILI ESTERNI

Surface and buried profiles



Outdoor

ALU PROOF

Low Luminance

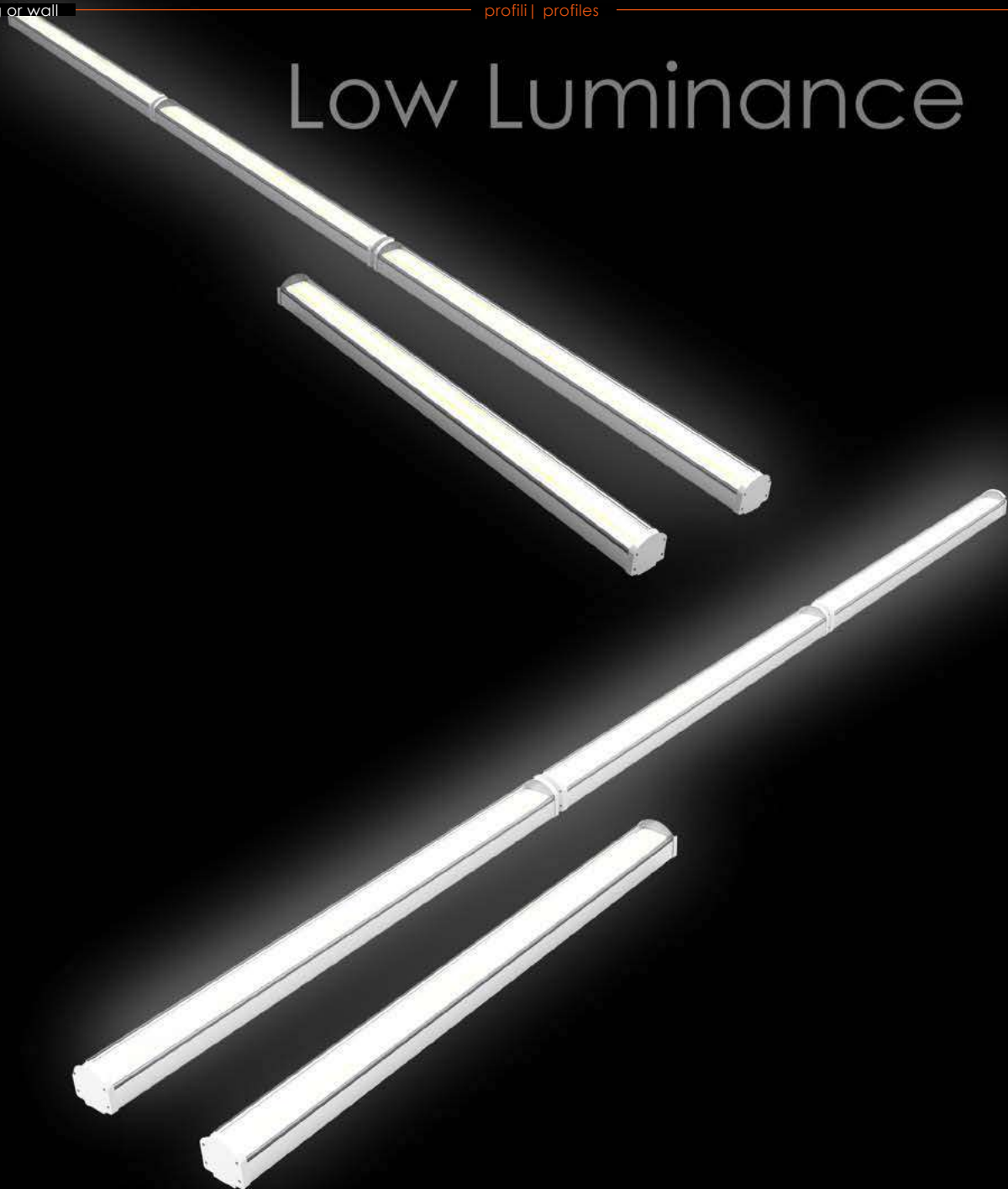

High Luminance

Profilo dal design semplice e curato ideale per tutte le installazioni. Adatto ad ambienti esterni e ad elevato utilizzo. Può essere usato singolarmente o a file continue.

Profile with a simple and refined design, ideal for all installations. Suitable for outdoor and high-use environments. It can be used individually or in continuous rows.

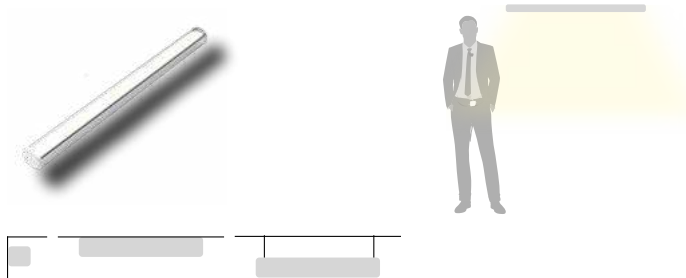

ALU PROOF

Alu si caratterizza per la sua estetica semplice adatta a tutti gli spazi di servizio e, grazie alla tripla protezione, si installa in qualsiasi contesto, indoor e outdoor.

Il sistema Tri-proof LED della plafoniera ALU la rende tre volte resistente: all'acqua, alla polvere e agli shock. Perfetto per tutti gli spazi ad elevata intensità di utilizzo e condizioni di ambienti variabili, come cantine, negozi, garage, pensiline, ecc.

Profilo in alluminio, con diffusore in policarbonato acidato.

Installabile singolarmente o in file continue.

Alu is characterized by its simple aesthetics suitable for all service spaces and, thanks to the triple protection, it can be installed in any context, indoor and outdoor.

The Tri-proof LED system of the ALU ceiling light makes it three times resistant: to water, dust and shocks. Perfect for all spaces with high intensity of use and conditions of variable environments, such as cellars, shops, garages, shelters, etc.

Aluminum profile, with acid-etched polycarbonate diffuser.

Can be installed individually or in continuous rows.

CE	IP65
LED	RG1
CRI 80/90	Driver incl.
L80 B10	Alu Body
50000H	Mac Adam 3
⏏	

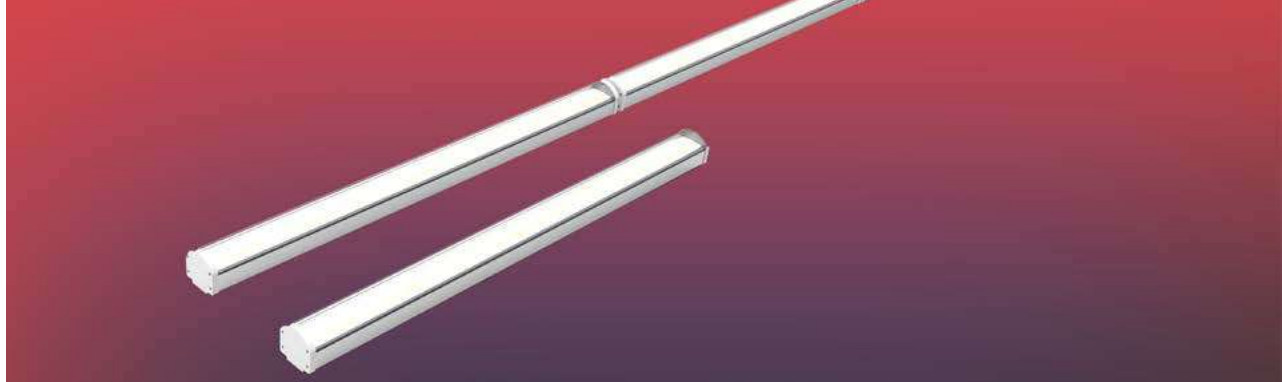

ALU PROOF

HIGH LUMINANCE

Z. anodizzato / anodised -05

COLOR

SINGLE INSTALLATION



CONTINUOUS INSTALLATION

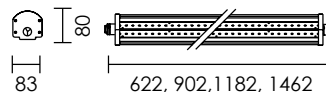

X.
CRI80
5

CRI90
6

Y.
4000K
7

3000K
8

DIM
1-10V
A1

DALI
A2

CODICE / CODE	L.MM	W	LM	DIFFUSORE / DIFFUSER
SINGLE INSTALLATION				
NEF.5661.0 X Y. Z	597	28W/230V LED	3938/3820lm	acidato/frosted
NEF.5662.0 X Y. Z	877	42W/230V LED	5918/5740lm	acidato/frosted
NEF.5663.0 X Y. Z	1157	56W/230V LED	7876/7640lm	acidato/frosted
NEF.5664.0 X Y. Z	1437	70W/230V LED	9856/9560lm	acidato/frosted
CONTINUOUS INSTALLATION				
NEF.5671.0 X Y. Z	622	28W/230V LED	3938/3820lm	acidato/frosted
NEF.5672.0 X Y. Z	902	42W/230V LED	5918/5740lm	acidato/frosted
NEF.5673.0 X Y. Z	1182	56W/230V LED	7876/7640lm	acidato/frosted
NEF.5674.0 X Y. Z	1462	70W/230V LED	9856/9560lm	acidato/frosted

ACCESSORI / ACCESSORIES



NEF.PS
Sensore di presenza.
Presence sensor for ALU.

€ 41,20



NEF.SO
Sospensione (coppia).
Suspension (pair).

€ 13,90

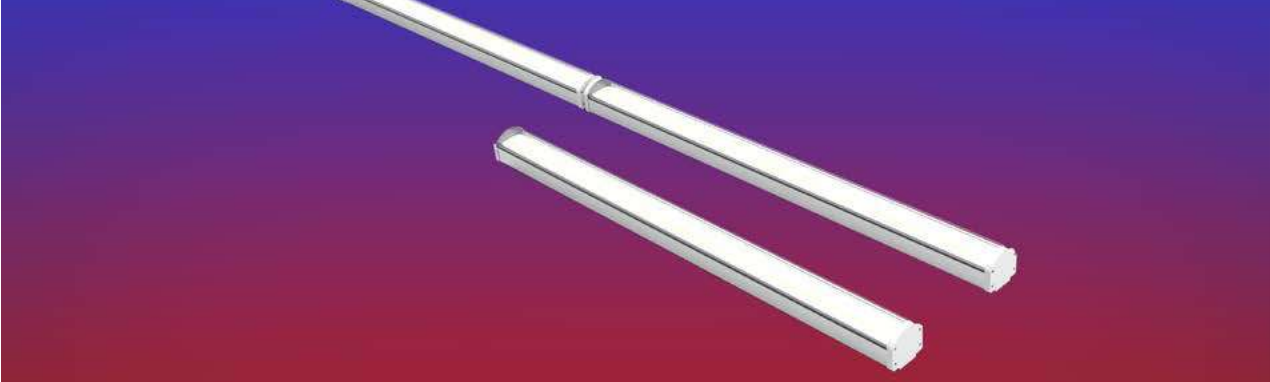

CE	IP65
LED	RG1
CRI 80/90	Driver incl.
L80 B10	Alu Body
50000H	Mac Adam 3
⏚	

05- anodizzato / anodised

Z. COLOR

ALU PROOF

LOW LUMINANCE

SINGLE INSTALLATION



CONTINUOUS INSTALLATION



CODICE / CODE L.MM W LM DIFFUSORE / DIFFUSER

SINGLE INSTALLATION

NEF.5666. 0 X Y. Z	597	17W/230V LED	2630/2380lm	acidato/frosted
NEF.5667. 0 X Y. Z	877	27W/230V LED	3945/3570lm	acidato/frosted
NEF.5668. 0 X Y. Z	1157	36W/230V LED	5260/4760lm	acidato/frosted
NEF.5669. 0 X Y. Z	1437	44W/230V LED	6575/5950lm	acidato/frosted

CONTINUOUS INSTALLATION

NEF.5676. 0 X Y. Z	622	17W/230V LED	2630/2380lm	acidato/frosted
NEF.5677. 0 X Y. Z	902	27W/230V LED	3945/3570lm	acidato/frosted
NEF.5678. 0 X Y. Z	1182	36W/230V LED	5260/4760lm	acidato/frosted
NEF.5679. 0 X Y. Z	1462	44W/230V LED	6575/5950lm	acidato/frosted

X. CRI80 5

CRI90 6

Y. 4000K 7

3000K 8

DIM 1-10V A1

DALI A2

ACCESSORI / ACCESSORIES



NEF.PS
Sensore di presenza.
Presence sensor for ALU.

€ 41,20



NEF.SO
Sospensione (coppia).
Suspension (pair).

€ 13,90



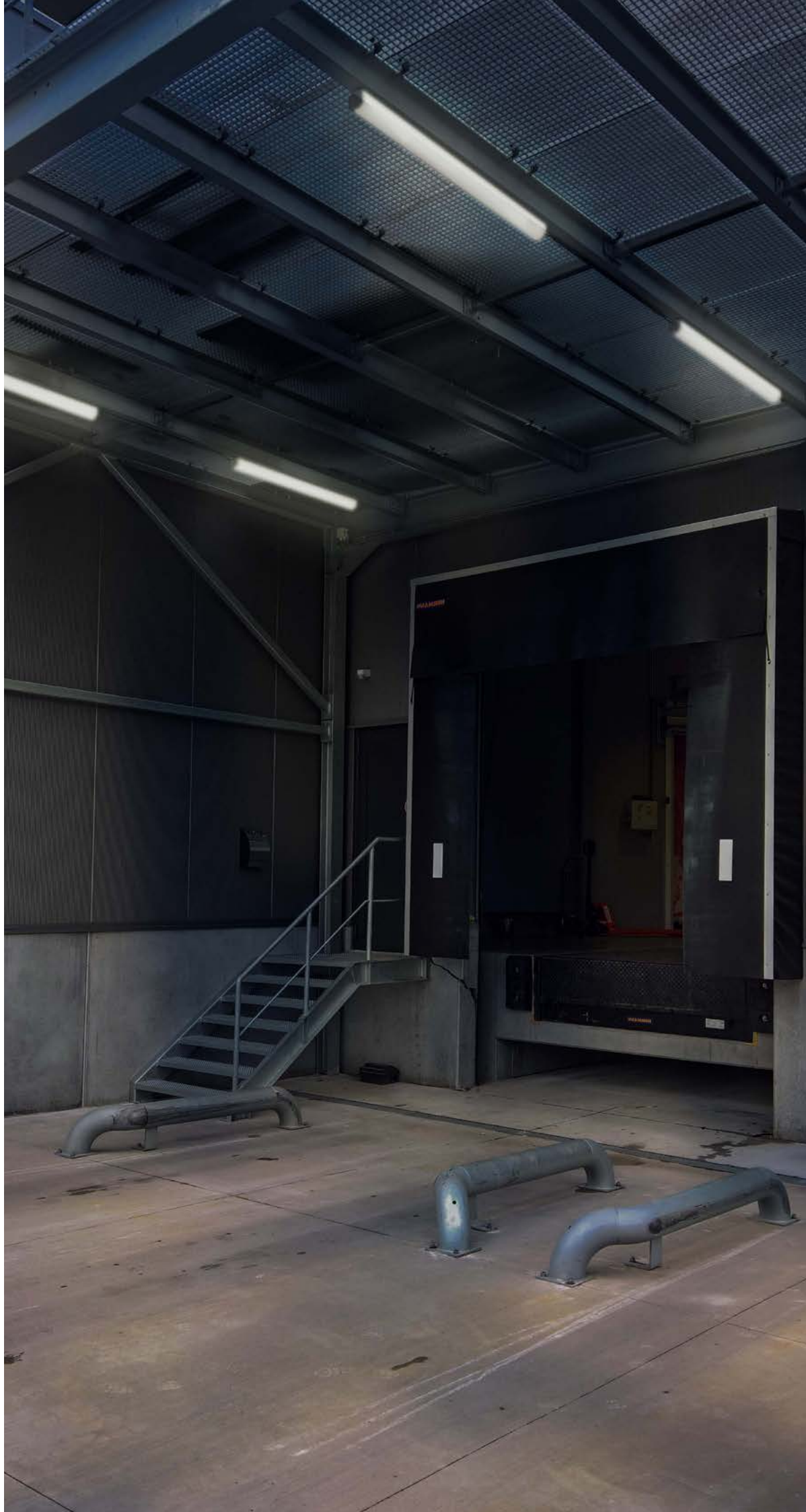

NET

Famiglia di apparecchi dalla forma tubolare, disponibile in diversi diametri e lunghezze è adatta alle più svariate possibilità d'installazione ed esigenze d'illuminazione. La forma sempre attuale ed il suo grado di protezione ne permette un utilizzo sia in ambienti esterni che interni laddove serva una maggiore sicurezza.

Family of tubular luminaires, available in different diameters and lengths, suitable for the most various installation possibilities and lighting needs. Its timeless shape and its degree of protection allows it to be suitable both outdoors and indoors where higher IP grade is needed.



Net 70



Net 16



Net 50



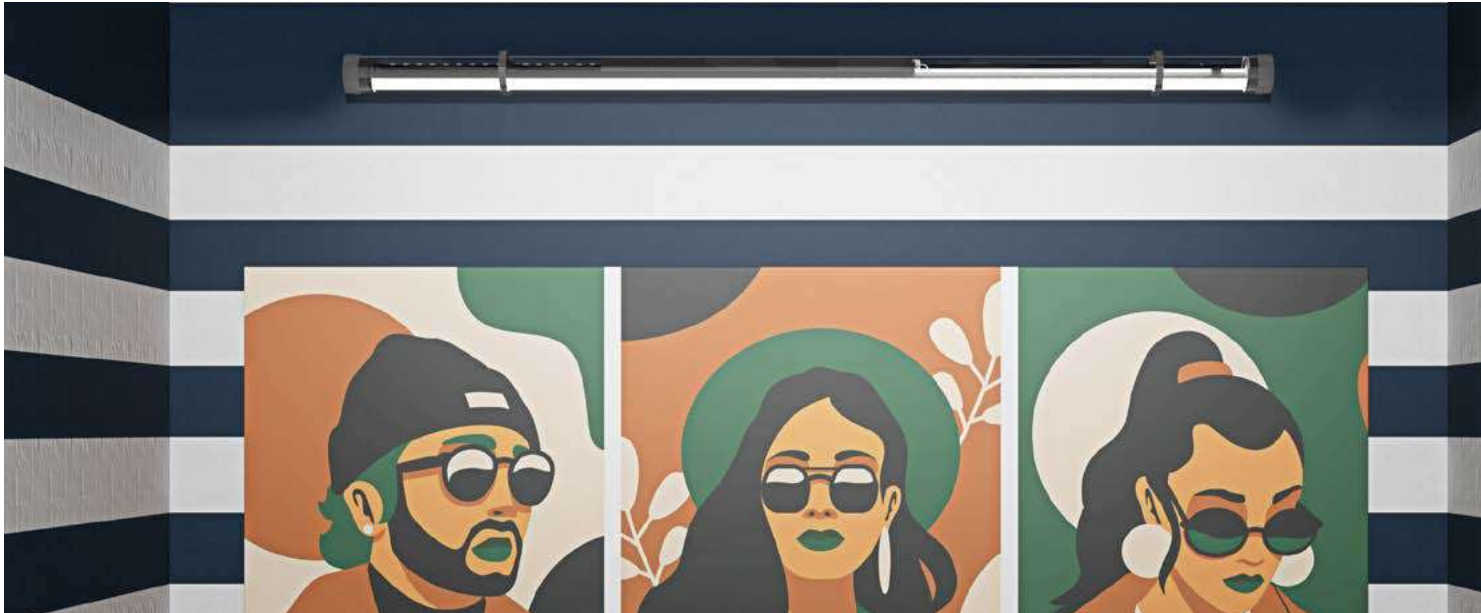

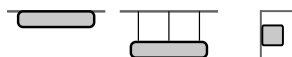

NET 16

Net 16 ha struttura interna in alluminio estruso, testate in lega di alluminio tornite sottoposte a trattamento di anodizzazione galvanica, diffusore in policarbonato trasparente o opale. Tono luce bianco 4000K o 3000K, potenze da 9.6W/1050mm a 43.2W/3050mm. Staffe di fissaggio e cavo di collegamento H05RN-F 2x1mm² inclusi. Driver remoto da ordinare separatamente.

Net 16 has internal structure in extruded aluminum, end caps in turned aluminum alloy with galvanic anodizing treatment. Transparent or opal polycarbonate diffuser. 4000K or 3000K LED white tone, power from 9.6W/1050mm to 43.2W/3050mm. Supplied with fixing brackets and H05RN-F 2x1mm² connecting cable. Remote driver to be ordered separately.

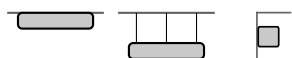

NET 50

Net 50 ha struttura interna in alluminio estruso, testate in lega di alluminio tornite sottoposte a trattamento di anodizzazione galvanica, diffusore in policarbonato esterno trasparente, interno satinato per luce diffusa o con lenti per luce concentrata. Tono bianco 4000K o 3000K, potenze da 30W/1150mm a 42x1.2/1790mm. Alimentatore elettronico incluso.

Net 50 has internal structure in extruded aluminum, end caps in turned aluminum alloy with galvanic anodizing treatment, External transparent polycarbonate diffuser with internal Opal screen for diffuse emission or with lenses for concentrate light. 4000K or 3000K LED white tone, power from 12.5W/605mm to 28WW/1205mm. Electronic driver included.

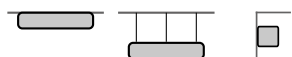

NET 70

Net 70 ha struttura interna in alluminio, testate in tecnopolimero resistente agli agenti atmosferici, diffusore in policarbonato opale. Tono luce bianco 4000K o 3000K, potenze da 38W /1257mm a 58W/1817mm. Alimentatore elettronico incluso.

Net 70 has internal structure in aluminum, end caps in weather-resistant techno polymer, opal polycarbonate diffuser. 4000K or 3000K LED white tone, power from 38W/1257mm to 58W/1817mm. Electronic driver included.

CE	IP65
LED	RG1
CRI 90	Mac Adam 3
L80 B10	50000H



NET 16

COLOR anodizzato / anodised -05

Y.
4000K
7

3000K
8

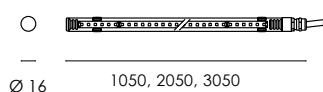

CODICE / CODE	L.MM	W	LM	DIFFUSORE/ DIFFUSER
120 LED/M				
NES.3341.1 6 Y. Z	1050	9,6W/24V LED	780/720	trasparente/clear
NES.3341.2 6 Y. Z	2050	19,2W/24V LED	1560/1440	trasparente/clear
NES.3341.3 6 Y. Z	3050	28,8W/24V LED	2340/2160	trasparente/clear
60 LED/M				
NES.3351.1 6 Y. Z	1050	9,6W/24V LED	780/720	opale/opal
NES.3351.2 6 Y. Z	2050	19,2W/24V LED	1560/1440	opale/opal
NES.3351.3 6 Y. Z	3050	28,8W/24V LED	2340/2160	opale/opal
120 LED/M				
NES.3342.1 6 Y. Z	1050	14,4W/24V LED	1060/990	trasparente/clear
NES.3342.2 6 Y. Z	2050	28,8W/24V LED	2120/1980	trasparente/clear
NES.3342.3 6 Y. Z	3050	43,2W/24V LED	3180/2970	trasparente/clear
60 LED/M				
NES.3352.1 6 Y. Z	1050	14,4W/24V LED	1060/990	opale/opal
NES.3352.2 6 Y. Z	2050	28,8W/24V LED	2120/1980	opale/opal
NES.3352.3 6 Y. Z	3050	43,2W/24V LED	3180/2970	opale/opal

ACCESSORI / ACCESSORIES



- AAA.TRSL08 Driver LED IP20 30W.
- AAA.TRSL09 Driver LED IP20 75W.
- AAA.TRSL10 Driver LED IP20 150W.
- AAA.TRSL13 Driver LED IP67 70W.
- AAA.TRSL15 Driver LED IP65 10W.



- NES.SO Sospensioni (coppia).
Suspension kit (pair).



CE	IP67
LED	RG1
CRI 90	Driver incl.
L80 B10	50000H
⏚	Mac Adam 3

05- anodizzato/anodised

COLOR

NET 50

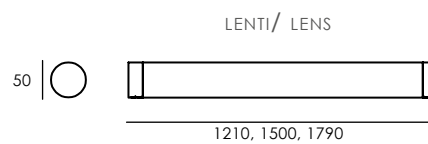
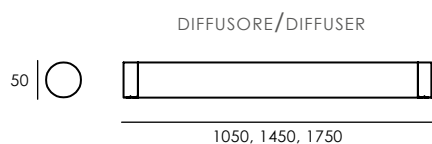

CODICE / CODE	L.MM	W	LM	FASCIO/ BEAM
DIFFUSORE/DIFFUSER				
NET.5743.0 6 Y. Z	1150	30W/230V LED	2304/2088	diffuso/ diffuse
NET.5744.0 6 Y. Z	1450	37W/230V LED	2930/2657	diffuso/ diffuse
NET.5745.0 6 Y. Z	1750	45W/230V LED	3560/3226	diffuso/ diffuse
LENTI/LENSES				
NET.5746.D 6 Y. Z	1210	28x1,2W/230V LED	3016/2590	15°-30°-10x45°
NET.5747.D 6 Y. Z	1500	35x1,2W/230V LED	3769/3237	15°-30°-10x45°
NET.5748.D 6 Y. Z	1790	42x1,2W/230V LED	4272/3669	15°-30°-10x45°

- D. 15° 1
- 30° 2
- 10x45° 3
- Y. 4000K 7
- 3000K 8

ACCESSORI / ACCESSORIES



NET.SO5
Sospensioni (coppia).
Suspension kit (pair).



NET.AP5
Attacco a parete o soffitto (coppia).
Wall or ceiling attachment (pair).

CE	IP65
LED	RG1
CRI 80/90	Driver incl.
L80 B10	50000H
	Mac Adam 3



NET 70

Z. grigio metallico/ metallic grey -28

COLOR

X.
CRI80
5

CRI90
6

DIM
1-10V
A1

DALI
A2

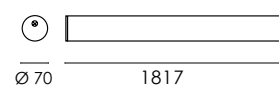
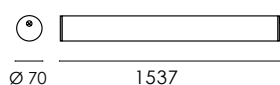
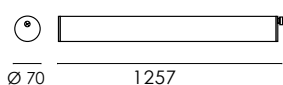

CODICE / CODE L.MM W K LM DIFFUSORE/ DIFFUSER

NEV.5713.1 X 7. Z 1257 38W/230V LED 4000K 5640 opale/opal
NEV.5713.1 X 8. Z 1257 38W/230V LED 3000K 5320 opale/opal

NEV.5714.1 X 7. Z 1537 48W/230V LED 4000K 7060 opale/opal
NEV.5714.1 X 8. Z 1537 48W/230V LED 3000K 6660 opale/opal

NEV.5715.1 X 7. Z 1817 58W/230V LED 4000K 8480 opale/opal
NEV.5715.1 X 8. Z 1817 58W/230V LED 3000K 8000 opale/opal

ACCESSORI / ACCESSORIES



NEV.AP2
Attacco a parete o soffitto. (coppia)
Wall or ceiling mount (pair).



NEV.AP4
Attacco a parete o soffitto. (coppia)
Wall or ceiling mount (pair).



NEV.SO
Sospensioni (coppia).
Suspension kit (pair).



AAA.RA2
Rosone alimentato basic.
Power supply basic.
AAA.RA2-A2
Rosone alimentato dimmerabile.
Power supply dimmable.



CABRIO

Cabrio
Cabrio RGBW

Famiglia di apparecchi lineari per esterno dal design contemporaneo che ci aiuta inserire la luce dove l'architettura l'ha sottratta: facciate di edifici, volte, portoni e pensiline. Grazie ai molteplici fasci disponibili è facile trovare la soluzione che più si adatta alle proprie esigenze che siano quelle di far risaltare un dettaglio o di realizzare un'illuminazione funzionale e/o decorativa.

A family of linear outdoor luminaires with a contemporary design that helps us insert light where architecture has stolen it: building facades, vaults, doors and canopies. Thanks to the multiple beams available, it is easy to find the solution that best suits your needs, whether they are to bring out a detail or to create functional and / or decorative lighting.

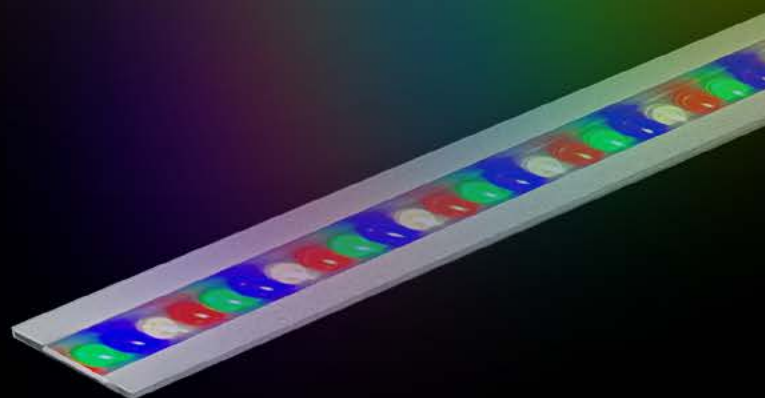
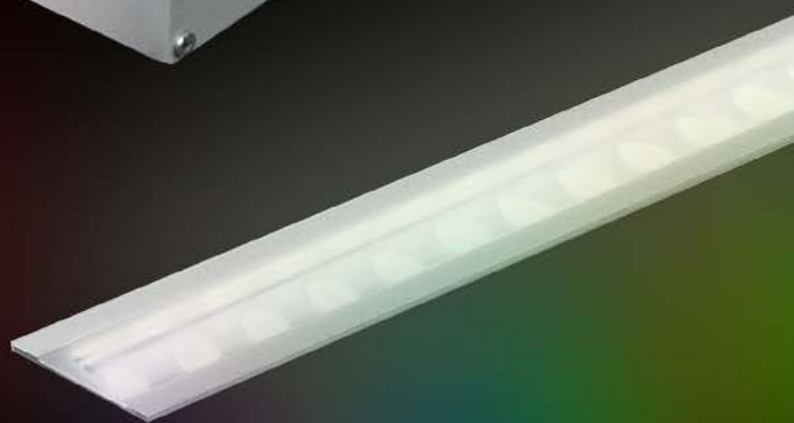

Cabrio Recessed
Cabrio Recessed RGBW

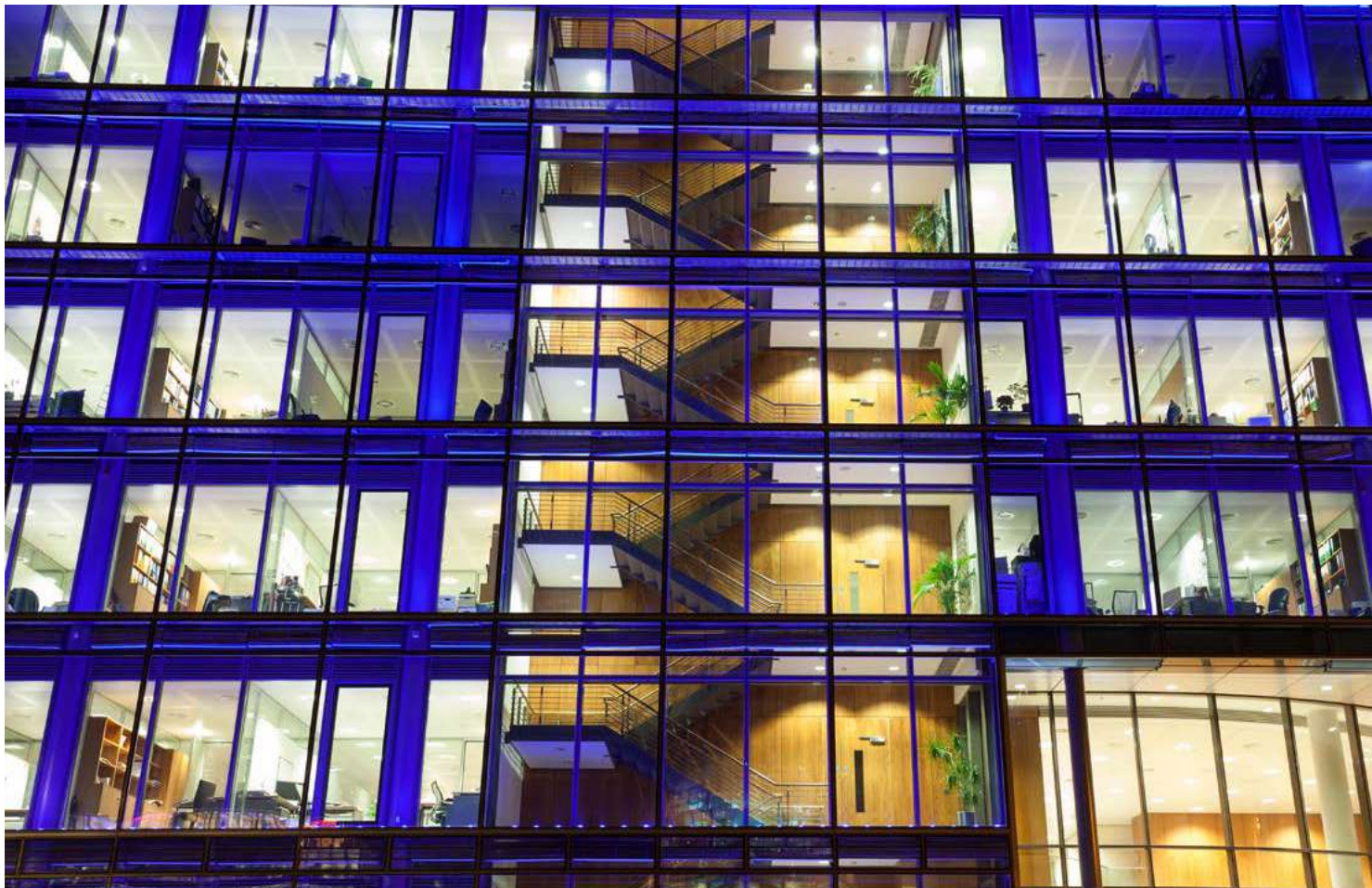

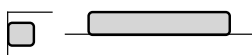

CABRIO

Struttura interamente in alluminio estruso finitura anodizzato ad elevata resistenza all'ossidazione. Diffusore in vetro temperato spessore 6 mm, satinato per luce diffusa o trasparente con lenti. Viti a brugola in acciaio INOX A4. Apparecchio precablato con cavo in neoprene, guarnizioni in silicone ricotto. Tono luce bianco 4000K o 3000K, Potenze da 12.5W /605mm a 28x1.2W/1205mm. Alimentatore elettronico incluso.

The structure is made of extruded aluminum, anodized finishing with high resistance against corrosion, tempered glass diffuser 6mm thick, frosted for diffuse light or transparent with lenses. Screws in stainless steel A4, prewired with Neoprene Cable, Silicon Gaskets. 4000K or 3000K LED white tone, from 12.5W /605mm to 28x1.2W/1205mm power. Electronic driver included.

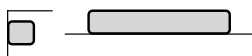

CABRIO RGBW

Struttura interamente in alluminio estruso finitura anodizzato ad elevata resistenza all'ossidazione. diffusore in vetro temperato spessore 6 mm, satinato per luce diffusa o trasparente con lenti. Viti a brugola in acciaio INOX A4. Apparecchio precablato con cavo in neoprene, guarnizioni in silicone ricotto. Tono luce RGBW. Potenze da 24x1.2W /615mm a 48x1.2W/1215mm. Alimentatore elettronico incluso.

The structure is made of extruded aluminum, anodized finishing with high resistance against corrosion, tempered glass diffuser 6mm thick, frosted for diffuse light or transparent with lenses. Screws in stainless steel A4, prewired with Neoprene Cable, Silicon Gaskets. RGBW tone, from 24x1.2W /615mm to 48x1.2W/1215mm power. Electronic driver included.





CE	IP65
LED	RG1
CRI 80	Driver incl.
L80 B10	50000H
	Mac Adam 3



CABRIO

Z.

COLOR

anodizzato/anodised -05	
antracite/anthracite -06	
grigio chiaro opaco/clear matt grey -37	
custom -99	

15°

1

30°

2

10X45°

3

11X30°

4

CR180

5

Y.

4000K

7

3000K

8

DIM.

1-10V

A1

DALI

A2

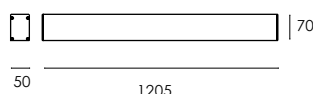

CODICE / CODE	L.MM	W	LM	FASCIO / BEAM
JEC.5916.0 5 Y. Z	605	12.5W/230V LED	1585/1502	diffuso/diffuse 120°
JEC.5921.1 5 Y. Z	605	14x1.2W/230V LED	1502/1295	stretto/narrow 15°
JEC.5921.2 5 Y. Z	605	14x1.2W/230V LED	1502/1295	largo/wide 30°
JEC.5921.3 5 Y. Z	605	14x1.2W/230V LED	1502/1295	ellittico/elliptical 10x45°
JEC.5921.4 5 Y. Z	605	14x1.2W/230V LED	1502/1295	ellittico/elliptical 11x30°
JEC.5918.0 5 Y. Z	1205	25W/230V LED	3170/3004	diffuso/diffuse 120°
JEC.5923.1 5 Y. Z	1205	28x1.2W/230V LED	3016/2590	stretto/narrow 15°
JEC.5923.2 5 Y. Z	1205	28x1.2W/230V LED	3016/2590	largo/wide 30°
JEC.5923.3 5 Y. Z	1205	28x1.2W/230V LED	3016/2590	ellittico/elliptical 10x45°
JEC.5923.4 5 Y. Z	1205	28x1.2W/230V LED	3016/2590	ellittico/elliptical 11x30°

ACCESSORI / ACCESSORIES



JEC.AP
Attacchi a parete (coppia).
Wall mount (pair).



AAA.CN3
Connettore IP68, 3vie.
IP68 waterproof connector, 3way.



JEC.APR
Ganci di fissaggio regolabili (coppia).
Fixing adjustable hook (pair).



AAA.CN4
Connettore IP68, 4vie.
IP68 waterproof connector, 4way.



CE	IP65
LED	RG1
Mac Adam 3	50000H
L80 B10	RGBW
⏚	

- 05-** anodizzato/anodised
- 06-** antracite/anthracite
- 37-** grigio chiaro opaco/clear matt grey
- 99-** custom

Z.
COLOR

CABRIO

RGBW

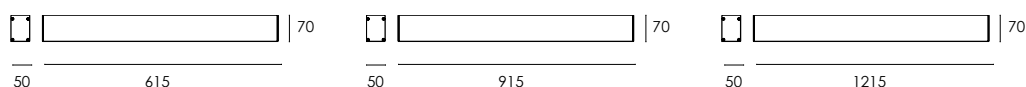

- D.**
15°
1
- 30°
2
- 10X45°
3

CODICE / CODE	L.MM	W	DRIVER
JEC.5931.D 99. Z	615	24x1.2W/230V RGBW	driver-dmx incluso/ driver-dmx included
JEC.5932.D 99. Z	915	36x1.2W/230V RGBW	driver-dmx incluso/ driver-dmx included
JEC.5933.D 99. Z	1215	48x1.2W/230V RGBW	driver-dmx incluso/ driver-dmx included

ACCESSORI / ACCESSORIES



AAA.TRSL27N
Centralina di controllo RGBW.
RGBW control unit.



JEC.AP
Attacchi a parete (coppia).
Wall mount (pair).



JEC.APR
Ganci di fissaggio (coppia).
Fixing hook (pair).



AAA.CN3
Connettore IP68, 3vie.
IP68 waterproof connector, 3way.



AAA.CN4
Connettore IP68, 4vie.
IP68 waterproof connector, 4way.





CABRIO RECESSED

Struttura interamente in alluminio estruso finitura anodizzato ad elevata resistenza all'ossidazione. Diffusore in vetro temperato spessore 6 mm, satinato per luce diffusa o trasparente con lenti. Viti a brugola in acciaio INOX A4. Apparecchio precablato con cavo in neoprene, guarnizioni in silicone ricotto. Tono luce bianco 4000K o 3000K, Potenze da 12.5W /605mm a 28x1.2W/1205mm. Alimentatore elettronico incluso. L'apparecchio va utilizzato con l'apposita cassaforma in lamiera di acciaio zincato dotata di alette che ne impediscono la deformazione da ordinare separatamente.

The structure is made of extruded aluminum, anodized finishing with high resistance against corrosion, tempered glass diffuser 6mm thick, frosted for diffuse light or transparent with lenses. Screws in stainless steel A4, prewired with Neoprene Cable, Silicon Gaskets. 4000K or 3000K LED white tone, from 12.5W /605mm to 28x1.2W/1205mm power. Electronic driver included. Recessed box in steel to be ordered separately.



CABRIO RECESSED RGBW

Struttura interamente in alluminio estruso finitura anodizzato ad elevata resistenza all'ossidazione. Diffusore in vetro temperato spessore 6 mm, satinato per luce diffusa o trasparente con lenti. Viti a brugola in acciaio INOX A4. Apparecchio precablato con cavo in neoprene, guarnizioni in silicone ricotto. Tono luce RGBW, Potenze da 24x1.2W /615mm a 48x1.2W/1215mm. Alimentatore elettronico incluso. L'apparecchio va utilizzato con l'apposita cassaforma in lamiera di acciaio zincato dotata di alette che ne impediscono la deformazione

The structure is made of extruded aluminum, anodized finishing with high resistance against corrosion, tempered glass diffuser 6mm thick, frosted for diffuse light or transparent with lenses. Screws in stainless steel A4, prewired with Neoprene Cable, Silicon Gaskets. RGBW tone, power from 24x1.2W /615mm to 48x1.2W/1215mm power. Electronic driver included.





CE	IP67
LED	RG1
CRI 80	Driver incl.
L80 B10	50000H
	Mac Adam 3



CABRIO

RECESSED



anodizzato/anodised -05 
 antracite/anthracite -06 
 grigio chiaro opaco/clear matt grey -37 
 custom -99 

15°
1

30°
2

10x45°
3

11x30°
4

CRI80
5

Y.
4000K
7

3000K
8

DIM.
1-10V
A1

DALI
A2

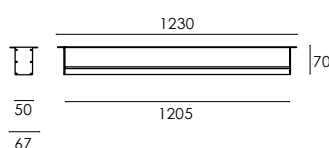
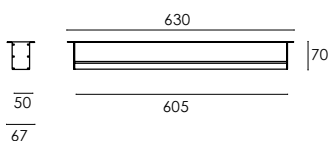

CODICE / CODE	L.MM	W	LM	FASCIO / BEAM
JED.5916.0 5 Y. Z	605	12.5W/230V LED	1585/1502	diffuso/diffuse 120° SYM
JED.5951.1 5 Y. Z	605	14x1.2W/230V LED	1502/1295	stretto/narrow 15° SYM
JED.5951.2 5 Y. Z	605	14x1.2W/230V LED	1502/1295	largo/wide 30° SYM
JED.5951.3 5 Y. Z	605	14x1.2W/230V LED	1502/1295	ellittico/ellip. 10x45° SYM
JED.5951.4 5 Y. Z	605	14x1.2W/230V LED	1502/1295	ellittico/ellip. 11x30° SYM
JED.5918.0 5 Y. Z	1205	25W/230V LED	3170/3004	diffuso/diffuse 120° SYM
JED.5953.1 5 Y. Z	1205	28x1.2W/230V LED	3016/2590	stretto/narrow 15° SYM
JED.5953.2 5 Y. Z	1205	28x1.2W/230V LED	3016/2590	largo/wide 30° SYM
JED.5953.3 5 Y. Z	1205	28x1.2W/230V LED	3016/2590	ellittico/ellip. 10x45° SYM
JED.5953.4 5 Y. Z	1205	28x1.2W/230V LED	3016/2590	ellittico/ellip. 11x30° SYM

ACCESSORI / ACCESSORIES

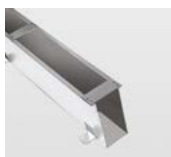

Cassaforma per incasso.
Recessed housing.

JED.C24 L.630mm.
JED.C54 L.1230mm.



JED.CD
Giunto lineare.
Linear joint.



AAA.CN3
Connettore IP68, 3vie.
IP68 waterproof connector, 3way.



AAA.CN4
Connettore IP68, 4vie.
IP68 waterproof connector, 4way.

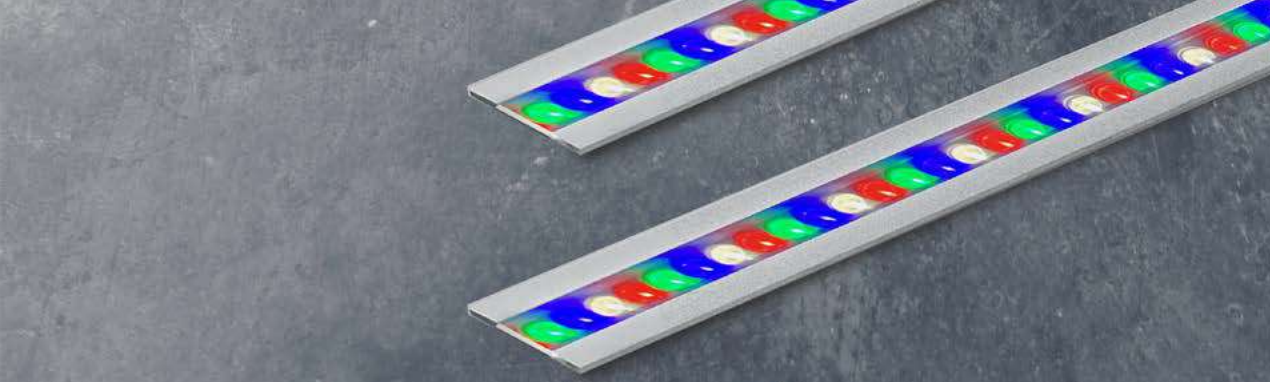

CE	IP67
LED	RG1
Mac Adam 3	50000H
L80 B10	RGBW

- 05-** anodizzato/anodised
 - 06-** antracite/anthracite
 - 37-** grigio chiaro opaco/clear matt grey
 - 99-** custom
- Z**
 COLOR

C A B R I O

R E C E S S E D R G B W

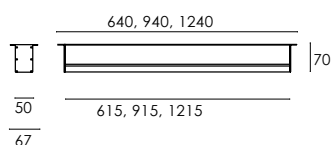

- D.** 15° **1**
- 30° **2**
- 10X45° **3**

CODICE / CODE	L.MM	W	DRIVER
JED.5941.D 99. Z	615	24x1.2W/230V RGBW	driver-dmx incluso/ driver-dmx included
JED.5942.D 99. Z	915	36x1.2W/230V RGBW	driver-dmx incluso/ driver-dmx included
JED.5943.D 99. Z	1215	48x1.2W/230V RGBW	driver-dmx incluso/ driver-dmx included

ACCESSORI / ACCESSORIES



Cassaforma per incasso.
Recessed housing.

- JED.C41** L.640mm.
- JED.C42** L.940mm.
- JED.C43** L.1240mm.



JED.CD
Giunto lineare.
Linear joint.



AAA.CN3
Connettore IP68, 3vie.
IP68 waterproof connector, 3way.



AAA.TRS127N
Centralina di controllo RGBW.
RGBW control unit.



AAA.CN4
Connettore IP68, 4vie.
IP68 waterproof connector, 4way.

RAISE

Raise è un apparecchio da incasso per esterni dagli ingombri ridotti e dalle linee eleganti ed essenziali che lo rendono la scelta ideale per essere utilizzato nell'illuminazione di viali, gradini, marciapiedi e camminamenti. Robustezza e resistenza completano il prodotto garantendone la funzionalità anche in aree di passaggio auto come ingressi di strutture alberghiere, cinema teatri etc.

Raise is an outdoor recessed luminaire with reduced dimensions and elegant and essential lines that make it the ideal choice to be used in the lighting of avenues, steps, sidewalks and walkways. Sturdiness and resistance complete the product, guaranteeing its functionality even in car passage areas such as hotel entrances, cinemas, theaters etc.



Carrabili





RAISE

Profilo carrabile in estruso di alluminio. Diffusore in vetro temperato (spessore 6 mm). Testate in alluminio pressofuso, guarnizioni in silicone e viteria in acciaio inox A4. Driver escluso.

The structure is made of extruded aluminum. Tempered glass diffuser (6mm thick). Die-cast aluminum end caps, silicon gaskets and stainless steel A4 screws. Driver excluded.

CE	IP67
LED	RG1
CRI 80/90	Mac Adam 3
L80 B10	Driveover Carrabile
50000H	

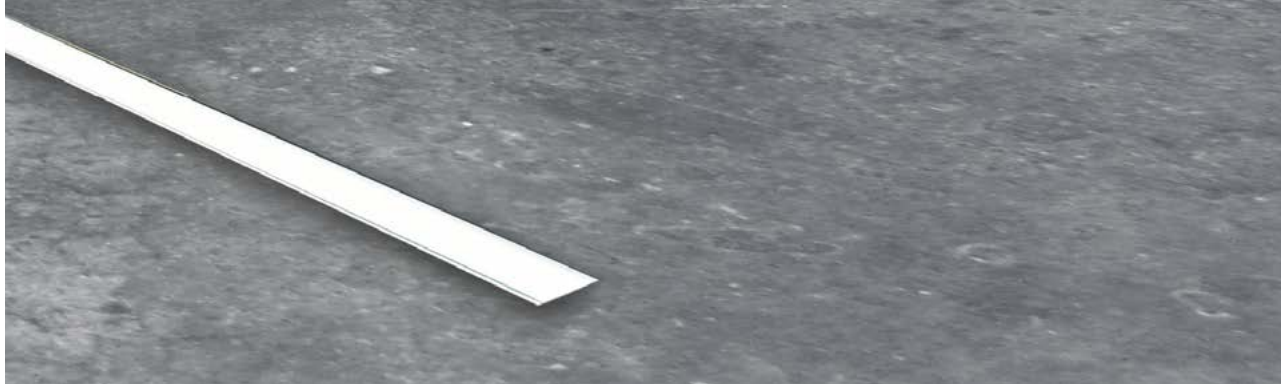

RAISE

Z.
COLOR grigio chiaro opaco/clear matt grey -37

X.
CRI80
5

CRI90
6

Y.
4000K
7

3000K
8

DIM.
1-10V
A1

DALI
A2

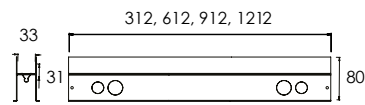
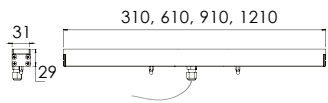

CODICE / CODE	L.MM	W	LM	FASCIO / BEAM	DRIVER
JER.5850.0 X Y. Z	310	7.5W/24V LED	576/522	108°	driver escluso/ driver excluded
JER.5851.0 X Y. Z	610	15W/24V LED	1152/1044	108°	driver escluso/ driver excluded
JER.5852.0 X Y. Z	910	22.5W/24V LED	1728/1560	108°	driver escluso/ driver excluded
JER.5853.0 X Y. Z	1210	30W/24V LED	2304/2088	108°	driver escluso/ driver excluded

ACCESSORI / ACCESSORIES



Cassaforma per incasso.
Recessed housing
JER.5850.000 L.310mm.
JER.5850.001 L.610mm.
JER.5850.002 L.910mm.
JER.5850.003 L.1210mm.



JER.5850.011
Testata di chiusura per cassaforma.
Endcap for R. housing.



JER.5850.010
Giunto per cassaforma.
Linear joint for recessed housing.



AAA.TRSL08
LED Driver IP20 30W 24VDC.



AAA.TRSL09
LED Driver IP20 75W 24VDC

AAA.TRSL13
LED Driver IP67 70W 24VDC.

AAA.TRSL16
LED Driver IP67 150W 24VDC



SPIDER

Famiglia di incassi a pavimento ad uso esterno disponibile in più versioni con diverse tipologie fasci, possono essere utilizzati singolarmente o in fila continua, per installazioni a parete o a pavimento. Sono adatti ad illuminare corridoi, portici o camminamenti, ma anche per grandi opere architettoniche e/o open-space.

Family of floor recessed luminaires for outdoor use available in several versions with different types of beams, they can be used individually or in a continuous row, for wall or floor installations. They are suitable for lighting corridors, arcades or walkways, but also for large architectural works and / or open-spaces.

Spider Recessed

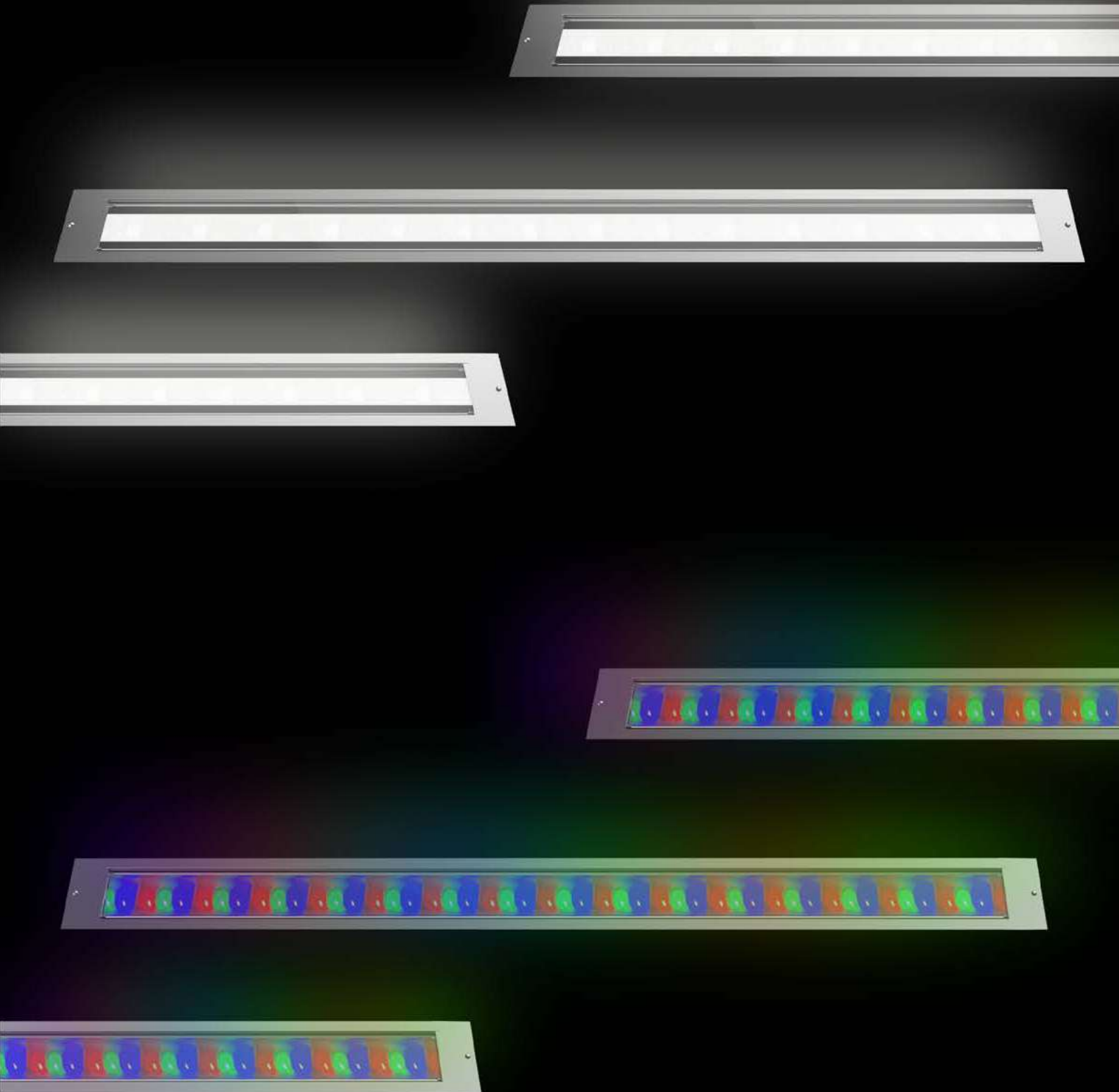

Spider Recessed RGB



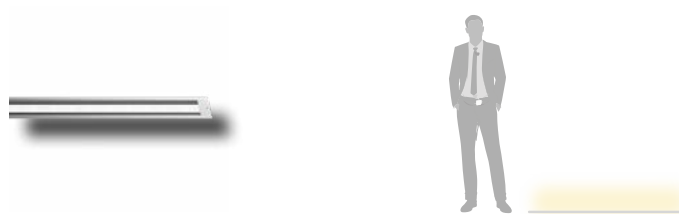

SPIDER RECESSED

Struttura in alluminio estruso finitura anodizzato ad elevata resistenza all'ossidazione. Testate in lega di alluminio pressofuso. Diffusore in vetro temperato spessore 6 mm, satinato per luce diffusa o trasparente con lenti. Viti a brugola in acciaio INOX A4. Apparecchio precablato con cavo in neoprene, guarnizioni in silicone ricotto. Tono luce bianco 4000K o 3000K. Potenze da 12.5W /660mm a 28W/1260mm. Alimentatore elettronico incluso. Cassaforma da ordinare separatamente.

The structure is made of extruded aluminum, anodized finishing with high resistance against corrosion, end-caps in aluminum alloy, tempered glass diffuser 6mm thick, frosted for diffuse light or transparent with lenses. Screws in stainless steel A4, prewired with Neoprene Cable, Silicon Gaskets. 4000K or 3000K LED white tone, from 12.5W /660mm to 28W/1260mm power. Electronic driver included. Recessed box in steel to be ordered separately.



SPIDER RECESSED RGB



Struttura in alluminio estruso finitura anodizzato ad elevata resistenza all'ossidazione. Testate in lega di alluminio pressofuso. Diffusore in vetro temperato spessore 6 mm trasparente con lenti. Viti a brugola in acciaio INOX A4. Apparecchio precablato con cavo in neoprene, guarnizioni in silicone ricotto. Potenze da 18led/960mm a 27led /1260mm. Alimentatore e cassaforma da ordinare separatamente.

The structure is made of extruded aluminum, anodized finishing with high resistance against corrosion, end-caps in aluminum alloy, tempered glass diffuser 6mm thick, transparent with lenses. Screws in stainless steel A4, prewired with Neoprene Cable, Silicon Gaskets, from 18leds/960mm to 27leds/1260mm power. Electronic driver and recessed box in steel to be ordered separately.





CE	IP67
LED	RG1
CRI 80	Driver incl.
L80 B10	50000H
	Mac Adam 3



SPIDER

RECESSED

Z.
COLOR

- anodizzato/anodised -05 
- antracite/anthracite -06 
- grigio chiaro opaco/clear matt grey -37 
- custom -99 

15°
1

30°
2

10x45°
3

11x30°
4

CRI80
5

Y.
4000K
7

3000K
8

DIM.
1-10V
A1

DALI
A2

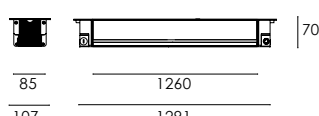
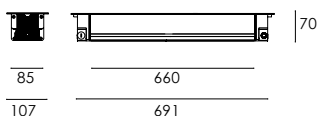

CODICE / CODE	L.MM	W	LM	FASCIO / BEAM
JAD.5816.0 5 Y. Z	660	12.5W/230V LED	1585/1502	diffuso/diffuse 120° SYM
JAD.5821.1 5 Y. Z	660	14x1.2W/230V LED	1502/1295	stretto/narrow 15° ASYM
JAD.5821.2 5 Y. Z	660	14x1.2W/230V LED	1502/1295	largo/wide 30° ASYM
JAD.5821.3 5 Y. Z	660	14x1.2W/230V LED	1502/1295	ellittico/ellip. 10x45° ASYM
JAD.5821.4 5 Y. Z	660	14x1.2W/230V LED	1502/1295	ellittico/ellip. 11x30° ASYM
JAD.5818.0 5 Y. Z	1260	25W/230V LED	3170/3004	diffuso/diffuse 120° SYM
JAD.5823.1 5 Y. Z	1260	28x1.2W/230V LED	3016/2590	stretto/narrow 15° ASYM
JAD.5823.2 5 Y. Z	1260	28x1.2W/230V LED	3016/2590	largo/wide 30° ASYM
JAD.5823.3 5 Y. Z	1260	28x1.2W/230V LED	3016/2590	ellittico/ellip. 10x45° ASYM
JAD.5823.4 5 Y. Z	1260	28x1.2W/230V LED	3016/2590	ellittico/ellip. 11x30° ASYM

ACCESSORI / ACCESSORIES



Cassaforma per incasso.
Recessed housing.

JAD.C24 L.691mm.
JAD.C21 L.991mm.
JAD.C54 L.1291mm.



JAD.PC
Pressacavo IP67.
Cable gland IP67.



DUC.MF3
Gancio di fissaggio (coppia).
Fixing hook (pair)



AAA.CN3
Connettore IP68, 3vie.
IP68 waterproof connector, 3way.



JAD.CA
Cavo anticaduta.
Suspension cable



AAA.CN4
Connettore IP68, 4vie.
IP68 waterproof connector, 4way.

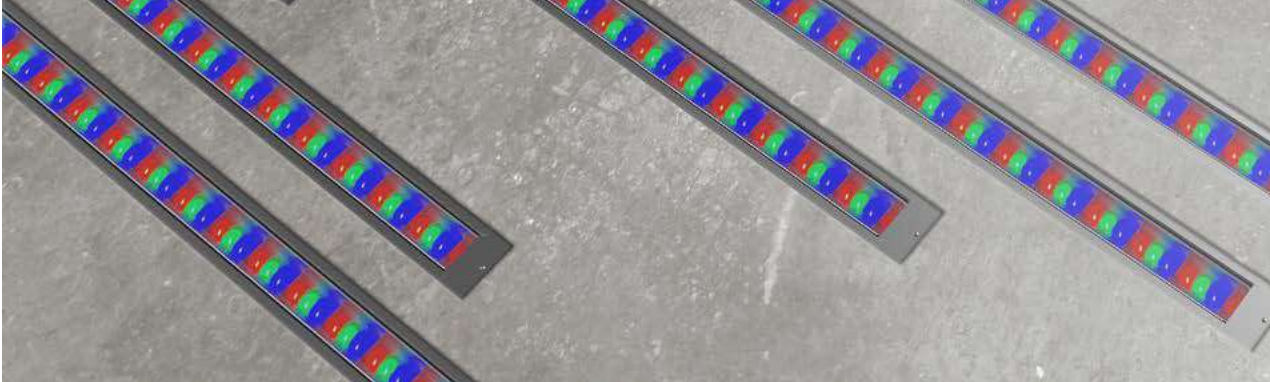

CE	IP67
LED	RG1
Mac Adam 3	50000H
L80 B10	RGB

- 05**- anodizzato/anodised
- 06**- antracite/anthracite
- 37**- grigio chiaro opaco/clear matt grey
- 99**- custom

Z.
COLOR

SPIDER

RECESSED RGB

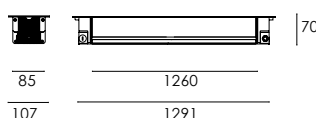
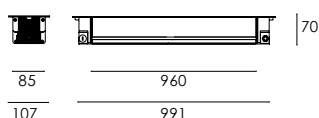

- D.** 15° **1**
- 30° **2**
- 10X45° **3**
- 11X30° **4**

CODICE / CODE	L.MM	W	LM	FASCIO / BEAM	DRIVER
JAD.5837.D 99. Z	960	18x1.2W/230V	RGB 478	ASYM	driver escluso/ driver excluded
JAD.5838.D 99. Z	1260	27x1.2W/230V	RGB 718	ASYM	driver escluso/ driver excluded

ACCESSORI / ACCESSORIES



Cassaforma per incasso.
Recessed housing.

JAD.C21 L.991mm.
JAD.C54 L.1291mm.



DUC.MF3
Gancio di fissaggio (coppia).
Fixing hook (pair)



JAD.CA
Cavo anticaduta.
Suspension cable



JAD.PC
Pressacavo IP67.
Cable gland IP67.



AAA.TRSL25
Interfaccia DMX.
DMX interface.



AAA.TRSL23
Driver RGB
Driver RGB



AAA.TRSL26
Controllo ad infrarossi.
Infrared system



AAA.TRSL27
Centralina di controllo DMX.
DMX control unit.



AAA.CN3
Connettore IP68, 3vie.
IP68 waterproof connector, 3way.



AAA.CN4
Connettore IP68, 4vie.
IP68 waterproof connector, 4way.

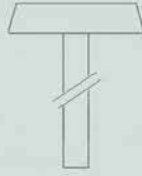
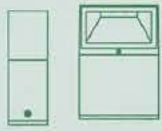

PALETTI E PROIETTORI

Poles & bollards



Outdoor

MINI ORFEO PRO



Mini Orfeo Pro è un apparecchio orientabile per esterni dal design essenziale, caratterizzato dalla forma quadrata. L'ampia disponibilità di modelli permette di creare effetti di illuminazione differenti.

Pensato per l'esterno per illuminare porticati, scale balconate e terrazzi.

Mini Orfeo Pro is an adjustable outdoor light fitting spotlight with an essential design, characterised by its square shape. The wide range of variations allows you to create different lighting effects.

Designed for outdoors to illuminate porches, stairs, balconies and terraces.



MINI ORFEO PRO

La struttura è in fusione di alluminio verniciato a polveri epossipoliestere. Vetro temperato trasparente. LED: tono luce bianco 4000K o 3000K. Dotato di ottiche o di riflettori sia metallizzati rotosimmetrici di diversi fasci o in alluminio a fascio diffuso. Potenze a partire da 1750 lm fino a 2650lm.

The structure is in die cast aluminum powder coated. LED. Tempered transparent safety glass. 4000K or 3000K white light tone. Equipped with Lenses or reflectors with different beams. Powers from 1750lm up to 2650lm.

Scopri anche / look at:

Mini Orfeo

pag. 36

Esterni a soffitto & parete

Exterior wall & ceiling



CE	IP65
LED	RG1
CRI 80/90	Driver incl.
L80 B10	Mac Adam 3
50000H	



MINI ORFEO PRO

Z. COLOR

- antracite/anthracite -06
- grigio chiaro/clear grey -37
- custom -99

X. CRI80 5

CRI90 6

Y. 4000K 7

3000K 8

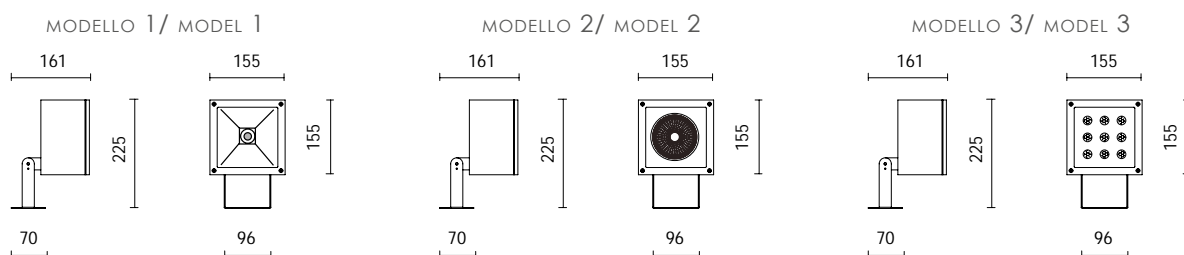

CODICE / CODE	W	LM	FASCIO / BEAM	DIFFUSORE / DIFFUSER
MODELLO 1/ MODEL 1				
MTP.5451. 0 X Y. Z	12,5W/230V LED	2650/2540	60°	trasparente/transparent
MTP.5451. 1 X Y. Z	12,5W/230V LED	2650/2540	60°	satinato/satin
MODELLO 2/ MODEL 2				
MTP.5453. 1 X Y. Z	12,5W/230V LED	2650/2540	13°	trasparente/transparent
MTP.5453. 2 X Y. Z	12,5W/230V LED	2650/2540	20°	trasparente/transparent
MTP.5453. 3 X Y. Z	12,5W/230V LED	2650/2540	38°	trasparente/transparent
MODELLO 3/ MODEL 3				
MTP.5454. 1 X Y. Z	18W/230V LED	1880/1750	15°	trasparente/transparent
MTP.5454. 2 X Y. Z	18W/230V LED	1880/1750	25°	trasparente/transparent
MTP.5454. 3 X Y. Z	18W/230V LED	1880/1750	38°	trasparente/transparent

ACCESSORI / ACCESSORIES

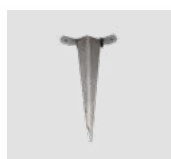

MTP.SP
Picchetto Inox.
Inox Spike.



MTP.AG
Schermo antiabbagliamento.
Anti-glare screen.



NIK



Apparecchio d'illuminazione orientabile per esterni. Il corpo ha un angolo di rotazione di 145°, permettendogli di essere utilizzato in molteplici soluzioni come porticati, facciate, spazi espositivi esterni e monumenti. Iconica la versione nero raggrinzante, disponibile anche in un'ampia gamma di altre finiture.

Adjustable exterior spotlight. The body has a rotation angle of 145°, allowing it to be used in a variety of solutions such as porches, facades, outdoor exhibition spaces and monuments. Iconic wrinkled black version, also available in a wide range of other finishes.



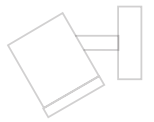
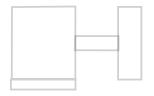

NIK

Corpo in alluminio pressofuso, diffusore in vetro temperato. L'alimentazione a 230V ne permette una maggior semplicità dell'impianto rendendolo di facile installazione.

Die cast aluminium body, tempered glass diffuser. The 230V power permits an higher simplicity of the electrical system making it easy to be installed.

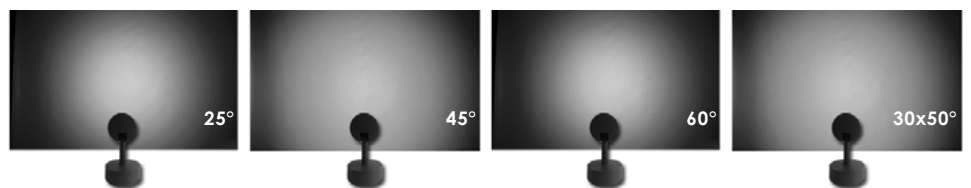

CE	IP66
LED	RG1
CRI 80/90	Driver incl.
L80 B10	Mac Adam 3
50000H	⚡

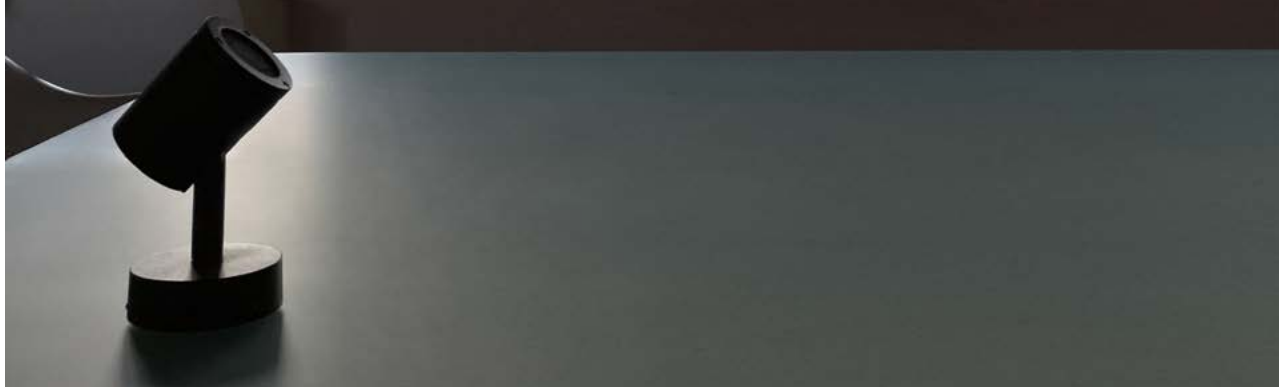

NIK

D.
25°
2

45°
3

30°x50°
4

60°
5

X.
CRI80
5



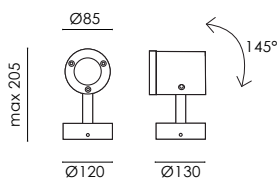

CRI90
6

4000K
7

3000K
8



Z.
COLOR

- antracite / anthracite - 06 
- bianco ragg. / rough white- 32 
- nero ragg. / rough black - 33 
- grigio chiaro / clear grey - 37 
- custom -99 

CODICE / CODE	W	K	LM	FASCIO / BEAM
NIK.4443. D X 7. Z	20W/230V LED COB	4000 K	2840	25°/45°/30°x50°/60°
NIK.4443. D X 8. Z	20W/230V LED COB	3000 K	2710	25°/45°/30°x50°/60°
GU 10				

NIK.4563.000. Z 20W/230V LED Gu10 lampada esclusa / lamp excluded

ACCESSORI / ACCESSORIES



NIK.SP
Picchetto Inox.
Inox Spike.



AAA.CN3
Connettore IP68, 3vie.
IP68 waterproof connector, 3way.



AAA.CN4
Connettore IP68, 4vie.
IP68 waterproof connector, 4way.



TITAN



Apparecchio orientabile per esterni dal tipico design lineare e funzionale, interamente in acciaio INOX. Il riflettore speculare sfaccettato per diversi fasci luminosi, ne permette la versatilità di utilizzo, sia per illuminazioni puntuali di monumenti e facciate, sia per giardini e architetture esterne.

Adjustable outdoor light fitting with a typical linear and functional design, entirely made of stainless steel. The faceted specular reflector for different light beams makes it versatile to use, both for spot lighting of monuments and facades and for gardens and outdoor architecture.

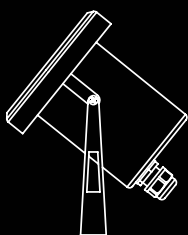
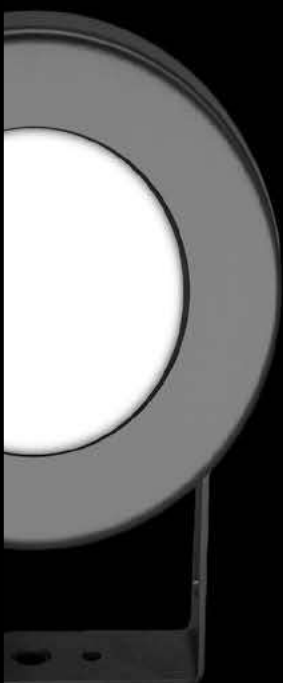





TITAN

Proiettore orientabile per esterni. Corpo e anello in acciaio inossidabile AISI 304L. Vetro trasparente. Driver incluso.

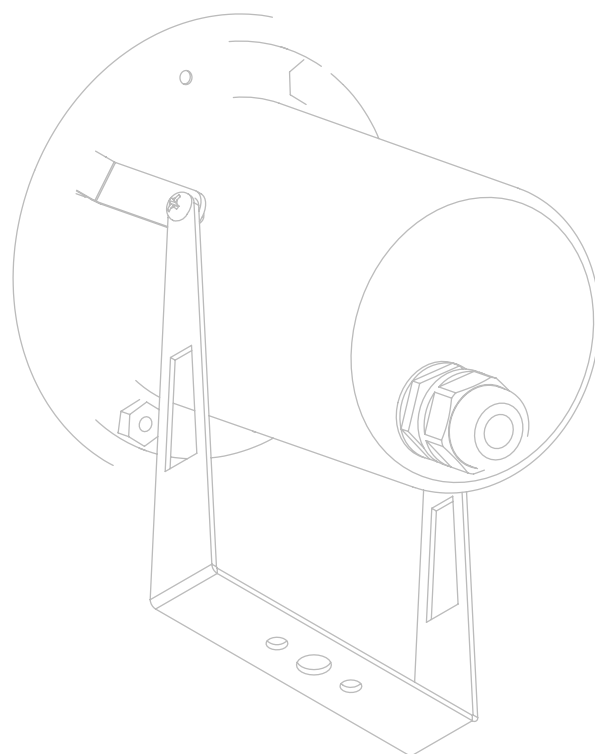

Adjustable projector for outdoor. Body and ring in stainless steel AISI 304L. Transparent glass. Driver included.



CE	IP65
LED	RG1
CRI 80/90	Driver incl.
L80 B10	Mac Adam 3
50000H	

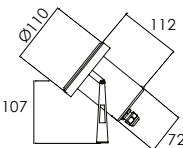

TITAN

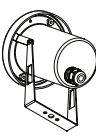
D.					
36° 1			86		
24° 2					
12° 3					
X.					
CRI80 5					
CRI90 6					
4000K 7					
3000K 8					
2700K 9					
	CODICE / CODE	W	K	LM	FASCIO / BEAM
	NTI.4702. D X 7	9W/230V LED	4000	890	36°/24°/12°
	NTI.4702. D X 8	9W/230V LED	3000	840	36°/24°/12°
	NTI.4702. D X 9	9W/230V LED	2700	770	36°/24°/12°

ACCESSORI / ACCESSORIES



NTI.SP
Picchetto Inox.
Inox Spike.



AAA.CN3
Connettore IP68, 3vie.
IP68 waterproof connector, 3way.



AAA.CN4
Connettore IP68, 4vie.
IP68 waterproof connector, 4way.



RA G G I O S P O T



Raggio Spot è un proiettore orientabile per esterno dalle dimensioni ridotte e dalle linee essenziali e discrete. Disponibile in 3 fasci di luce, garantisce versatilità e precisione nell'illuminazione di facciate, balconi ed architetture esterne.

Può essere inoltre la soluzione ideale per l'illuminazione di spazi verdi quali giardini, aiuole e piantumazioni.

Raggio Spot is an adjustable outdoor projector with small dimensions and essential, discreet lines. Available in three light beams, it guarantees versatility and precision in the illumination of facades, balconies and outdoor architecture.

It can also be the ideal solution for lighting green spaces such as gardens, flowerbeds and plantings.

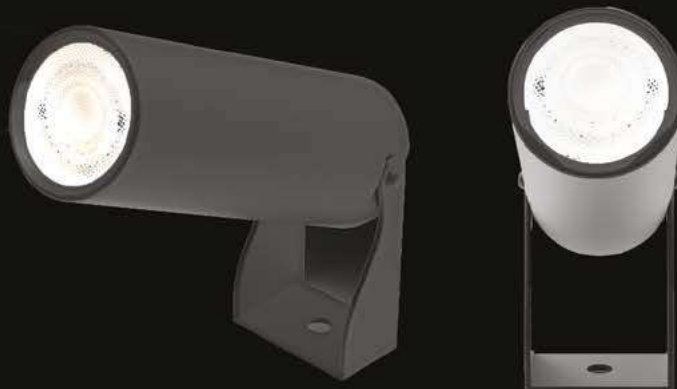



RAGGIO SPOT

Corpo e anello di chiusura in lega di alluminio sottoposti a pre-trattamento di anodizzazione galvanica. Grado di protezione IP65. Schermo di protezione in vetro trasparente temperato. Equipaggiato con un LED di colore bianco 4000K o 3000K da alimentare direttamente a 230V. Potenza 7W. Fornito completo di cavo di collegamento H05RN-F 3x1mm². Staffa inclusa.

Body and closing ring in aluminum alloy with galvanic anodizing pre-treatment. IP65 protection degree. Protection shield made of transparent tempered glass. Equipped with one LED in 4000K or 3000K color to be supplied at 230V. Power 7W. Supplied with H05RN-F 3x1mm² connecting cable. Bracket included.

Scopri anche / look at:

RAGGIO FAMILY

pag. 140

Incassi a pavimento



Buried & uplights



CE	IP65
LED	RG1
CRI 80	Driver incl.
L80 B10	Mac Adam 3
50000H	



RAGGIO SPOT

Z. COLOR	antracite / anthracite - 06	
	grigio chiaro opaco/clear matt grey - 37	
	custom -99	

D.
18°
1

36°
2

60°
3

CR180
5

4000K
7

3000K
8

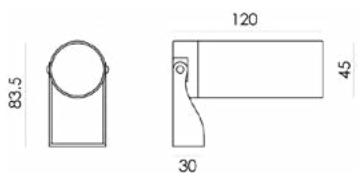

CODICE / CODE	W	K	LM	FASCIO / BEAM
LAA.5107. D 5 7. Z	7W/230V LED	4000	840	18°/36°/60°
LAA.5107. D 5 8. Z	7W/230V LED	3000	793	18°/36°/60°

ACCESSORI / ACCESSORIES



LAA.SP
Picchetto Inox.
Inox Spike.



LAA.AS
Asta h.300mm con picchetto.
Rod h.300mm with spike.



AAA.CN3
Connettore IP68, 3vie.
IP68 waterproof connector, 3way.



AAA.CN4
Connettore IP68, 4vie.
IP68 waterproof connector, 4way.



TEBE



Un nuovo elemento arricchisce la collezione di apparecchi in acciaio INOX in casa CIVIC. Pensato per illuminare verso il basso con una distribuzione uniforme della luce, TEBE è la soluzione perfetta per giardini ed esterni residenziali di ogni tipo. TEBE viene proposto come elemento completo di palo di diverse altezze o come lampada da montare su qualsiasi palo Ø 60 mm.

A new element enriches the CIVIC collection of stainless steel fittings. Designed for a uniform downward light distribution, TEBE is the perfect solution for gardens and residential exteriors in general. TEBE is proposed complete with pole of different heights or as element to be mounted on any 60 mm pole.



TEBE

Corpo interamente in acciaio inox AISI 304. Grado di protezione IP65. Schermo di protezione in policarbonato satinato infrangibile. Guarnizione in gomma al silicone. Equipaggiato con LED di colore bianco 4000K o 3000K. Potenze da 13W a 17W. Fornito completo di driver integrato nella struttura e di cavo di collegamento H05RN-F 3x1mm.

Structure and closing ring made of AISI 304 stainless steel. IP67 protection degree. Protection shield made in satin polycarbonate. Silicone rubber gasket. Equipped with white LED 4000K or 3000K. Powers from 13W to 17W. Supplied complete with built in driver and H05RN-F 3x1mm connection cable.

CE	IP65
LED	RG1
CRI 80	Driver incl.
L80 B10	Mac Adam 3
50000H	



TEBE

CRI80

5

Y.

4000K

7

3000K

8

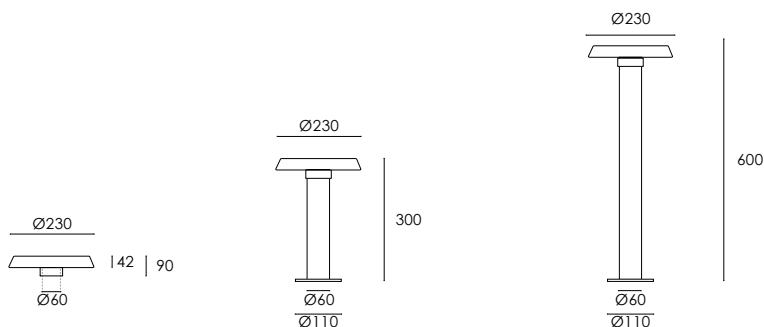

CODICE / CODE	H.MM	W	LM	PALO/POLE
SOLO TESTA/ ONLY HEAD				
MTY.7001.0 5 Y		13W/230V LED	2100/2000	palo escluso/pole exluded
MTY.7002.0 5 Y		17W/230V LED	2700/2550	palo escluso/pole exluded
			300 MM	
MTY.7031.0 5 Y	300	13W/230V LED	2100/2000	palo incluso/pole included
MTY.7032.0 5 Y	300	17W/230V LED	2700/2550	palo incluso/pole included
			600 MM	
MTY.7061.0 5 Y	600	13W/230V LED	2100/2000	palo incluso/pole included
MTY.7062.0 5 Y	600	17W/230V LED	2700/2550	palo incluso/pole included

ACCESSORI / ACCESSORIES



MTY.TF
Tirafondi per muratura.
Pole fixing bolts.



MINI A P O L L O P A L E T T O



Palletto per l'illuminazione di giardini, passaggi, aree residenziali. Le sue due altezze e la possibilità della doppia illuminazione lo rendono adatto a svariati ambienti e situazioni, potendo creare differenti soluzioni lumiose.

La lavorazione realizzata sul vetro ne permette il perfetto posizionamento a filo della cornice.

Bollard for lighting gardens, walkways and residential areas. Its two heights and the possibility of double lighting make it suitable for a variety of environments and situations, creating different lighting solutions.

The processing carried out on the glass allows it to be perfectly positioned flush with the frame.



MINI APOLLO PALETTO

La struttura è in alluminio estruso verniciato a polveri, il diffusore in vetro temperato. Disponibile in due altezze: 200 mm e 500 mm per un' illuminazione bi e mono direzionale.

The structure is in powder coated extruded aluminium, tempered glass diffuser. Available in 2 heights: 200mm and 500mm to have a single and bidirectional light emission.



Scopri anche / look at:

Apollo & Mini Apollo

pag. 30

Esterni a soffitto & parete

Exterior wall & ceiling





CE	IP65
LED	RG1
CRI 80/90	Driver incl.
L80 B10	Mac Adam 3
50000H	



MINI APOLLO PALETTO

Z.
COLOR

antracite/anthracite - **06** 
 grigio chiaro opaco/clear matt grey - **37** 
 custom - **99** 

X.
CRI80
5

CRI90
6

Y.
4000K
7

3000K
8

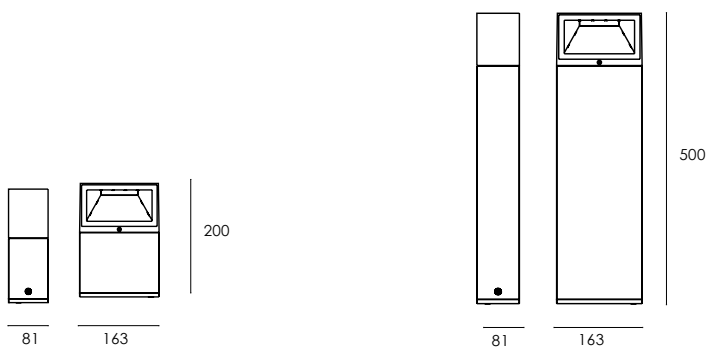

CODICE / CODE	H.MM	W	LM	EMISSIONE / EMISSION
				200 MM
MTA.5465.2 X Y. Z	200	8x1.2W LED	752/680	bidirezionale/bi directional
MTA.5466.2 X Y. Z	200	8x1.2W LED	752/680	monodirezionale/mono directional
				500 MM
MTA.5467.2 X Y. Z	500	8x1.2W LED	752/680	bidirezionale/bi directional
MTA.5468.2 X Y. Z	500	8x1.2W LED	752/680	monodirezionale/mono directional

ACCESSORI / ACCESSORIES



MTA.TF
Tirafondi per muratura.
Pole fixing bolts.

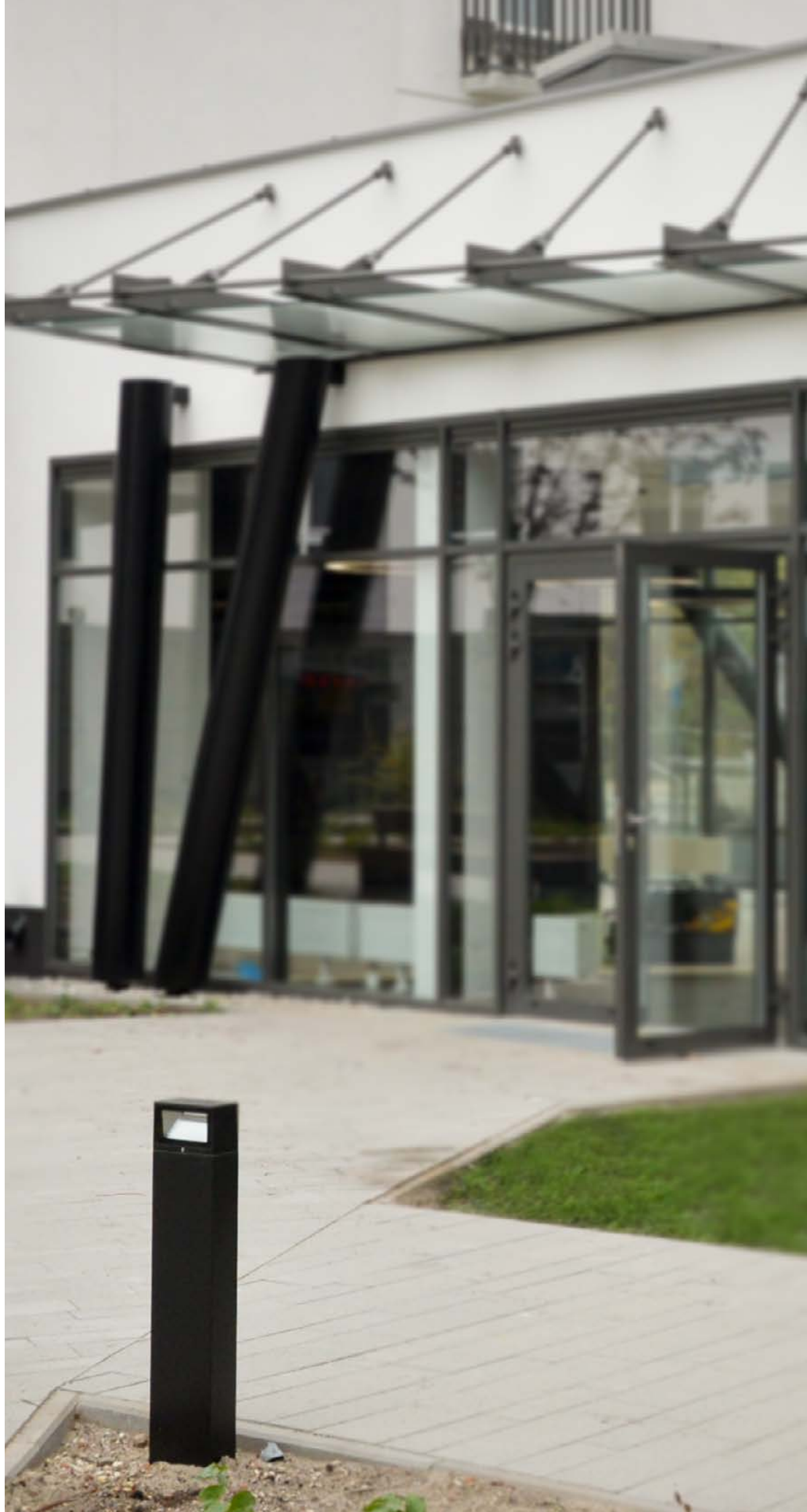



INCASSI A PAVIMENTO

Buried & uplights

Outdoor



CARRABILI DRIVEWAY



Sono gli incassi a terra storici di Civic. Le nuove fonti luminose e la nuova tecnologia produttiva mantengono questa collezione originale e al passo con i tempi. La famiglia è realizzata interamente in acciaio Inox offrendo maggior resistenza e durata nel tempo.

Civic's historic ground recessed range. The new sources and the new production technology, maintains this range up to date. The construction entirely in Stainless steel ensure reliability and quality along the time.

Carrabili



Era
Diana

Perseo
Zeus







ZEUS

Corpo e anello di chiusura in acciaio inox AISI 304. Grado di protezione IP67. Schermo di protezione in vetro trasparente temperato di spessore 12mm con resistenza meccanica IK 10 per passaggio veicolare. Guarnizione in gomma al silicone. Riflettore fisso asimmetrico o orientabile. Equipaggiato con un LED di colore bianco 4000K o 3000K. Potenze da 17W a 24W. Fornito completo di driver integrato nella struttura e di cavo di collegamento H05RN-F 3x1mm².

Structure and closing ring made of AISI 304 stainless steel. IP67 protection degree. Protection shield made of transparent tempered glass with 12mm thickness and IK 10 shock resistance for vehicle passage use. Silicone rubber gasket. Fixed, asymmetric or adjustable reflector. Equipped with one LED in 4000K or 3000K color temperature. Power from 17W up to 24W. Supplied with built-in driver and H05RN-F 3x1mm² connecting cable.



PERSEO

Corpo e anello di chiusura in acciaio inox AISI 304. Grado di protezione IP67. Schermo di protezione in vetro trasparente temperato di spessore 12mm con resistenza meccanica IK 10 per passaggio veicolare. Guarnizione in gomma al silicone. Riflettore fisso asimmetrico o orientabile. Equipaggiato con un LED di colore bianco 4000K o 3000K. Potenza 17W. Fornito completo di driver integrato nella struttura e di cavo di collegamento H05RN-F 3x1mm².

Structure and closing ring made of AISI 304 stainless steel. IP67 protection degree. Protection shield made of transparent tempered glass with 12mm thickness and IK 10 shock resistance for vehicle passage use. Silicone rubber gasket. Fixed, asymmetric or adjustable reflector. Equipped with one LED in 4000K or 3000K color temperature. Power 17W. Supplied with built-in driver and H05RN-F 3x1mm² connecting cable.

CE	IP67
LED	RG1
CRI 80/90	Driver incl.
L80 B10	Driveover Carrabile
50000H	Mac Adam 3



Z E U S

D.
OPTIC
38° 1

OPTIC
20° 2

OPTIC
13° 3

X.
CRI80
5

CRI90
6

Y.
4000K
7

3000K
8

FISSO / FIXED

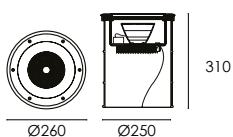

ORIENTABILE / ADJUSTABLE

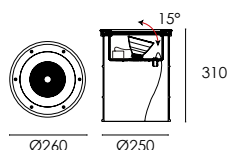

ASIMMETRICO / ASYMMETRIC

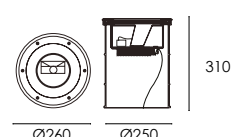

CODICE / CODE	D.MM	W	LM	DRIVER
FISSO / FIXED				
JEZ.5580. D X Y	Ø260	24W/230V LED	3710/3550	built-in/incorporato
ORIENTABILE / ADJUSTABLE				
JEZ.5581. D X Y	Ø260	17W/230V LED	2700/2550	built-in/incorporato
ASIMMETRICO / ASYMMETRIC				
JEZ.5582. 1 X Y	Ø260	24W/230V LED	3710/3550	built-in/incorporato

ACCESSORI / ACCESSORIES



JEZ.FG
Vetro sabbato
Sanded glass.



JEZ.FR2
Cornice quadrata
Square ring.



AAA.CN3
Connettore IP68, 3vie.
IP68 waterproof connector, 3way.



AAA.CN4
Connettore IP68, 4vie.
IP68 waterproof connector, 4way.



CE	IP67
LED	RG1
CRI 80/90	Driver incl.
L80 B10	Driveover Carrabile
50000H	Mac Adam 3
⏚	

PERSEO

FISSO / FIXED

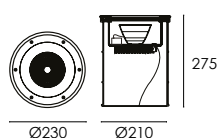

ORIENTABILE / ADJUSTABLE

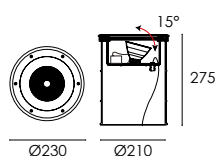

ASIMMETRICO / ASYMMETRIC

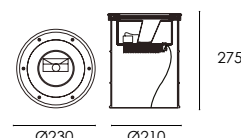

CODICE / CODE	D.MM	W	LM	DRIVER
FISSO / FIXED				
JEP.5590. D X Y	Ø230	17W/230V LED	2700/2550	built-in/incorporato
ORIENTABILE / ADJUSTABLE				
JEP.5591. D X Y	Ø230	17W/230V LED	2700/2550	built-in/incorporato
ASIMMETRICO / ASYMMETRIC				
JEP.5592. D X Y	Ø230	17W/230V LED	2700/2550	built-in/incorporato

D.
OPTIC
38° 1

OPTIC
20° 2

OPTIC
13° 3

X.
CRI80 5

CRI90 6

Y.
4000K 7

3000K 8

ACCESSORI / ACCESSORIES



JEP.FG
Vetro sabbiato
Sanded glass.



JEP.FR2
Cornice quadrata
Square ring.



AAA.CN3
Connettore IP68, 3vie.
IP68 waterproof connector, 3way.



AAA.CN4
Connettore IP68, 4vie.
IP68 waterproof connector, 4way.

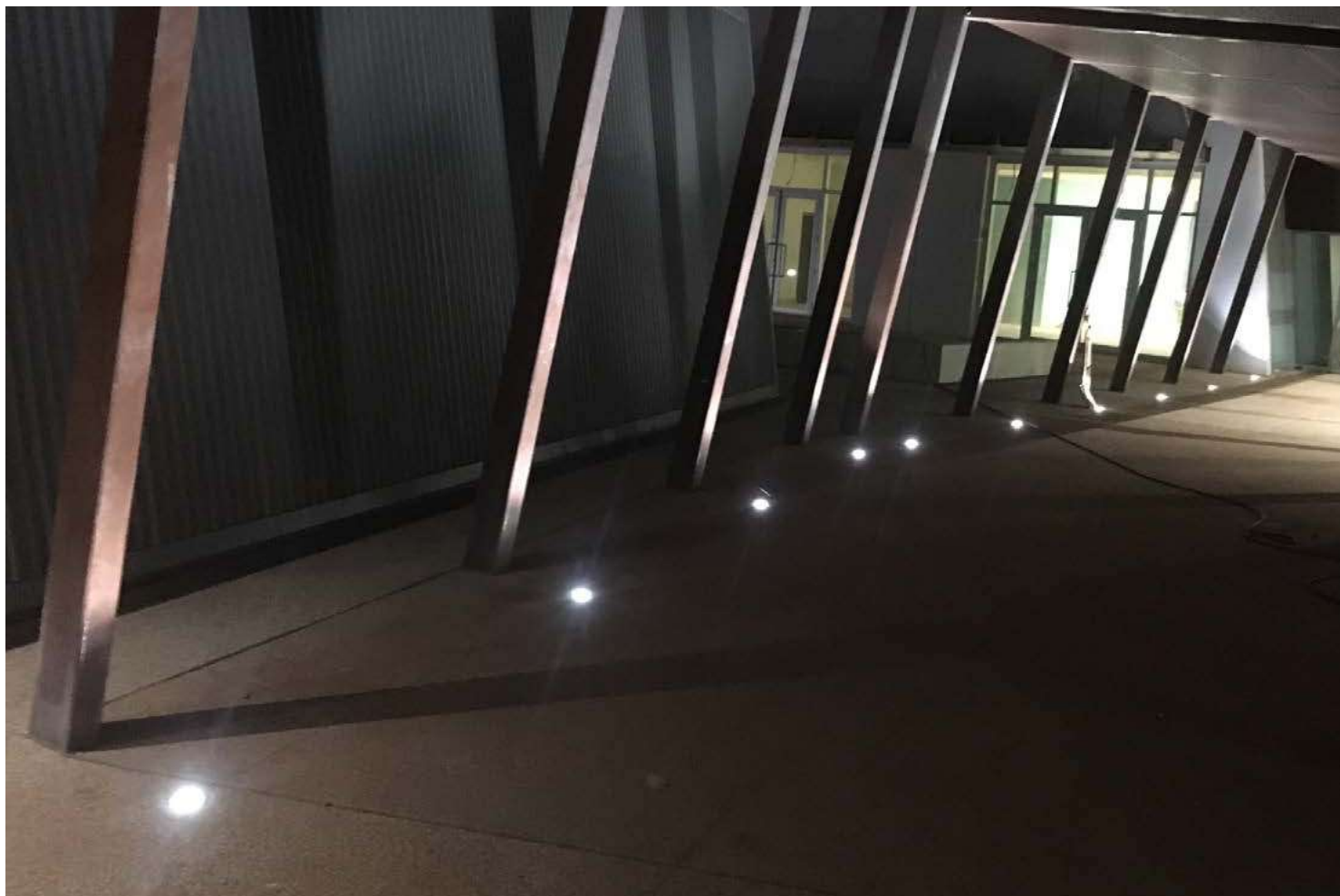
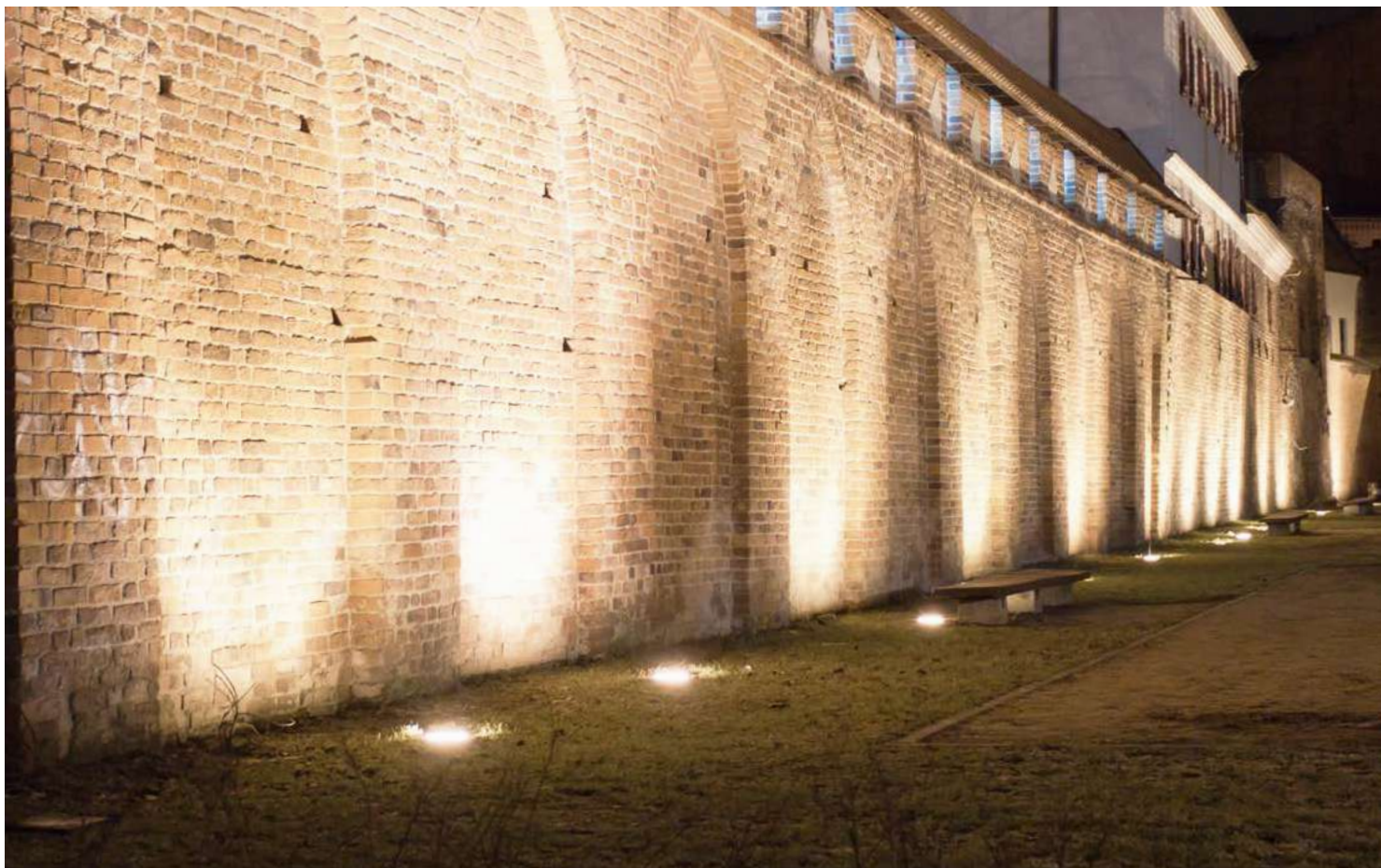



ERA

Corpo e anello di chiusura in acciaio inox AISI 304. Grado di protezione IP67. Schermo di protezione in vetro trasparente temperato di spessore 10mm con resistenza meccanica IK 10 per passaggio veicolare. Guarnizione in gomma al silicone. Equipaggiato con un LED di colore bianco 4000K o 3000K. Potenza da 13W. Fornito completo di driver integrato nella struttura e di cavo di collegamento H05RN-F 3x1mm².

Structure and closing ring made of AISI 304 stainless steel. IP67 protection degree. Protection shield made of transparent tempered glass with 10mm thickness and IK 10 shock resistance for vehicle passage use. Silicone rubber gasket. Fixed reflector. Equipped with one LED in 4000K or 3000K color temperature. Power 13W. Supplied with built-in driver and H05RN-F 3x1mm² connecting cable.



DIANA



Corpo e anello di chiusura in acciaio inox AISI 304. Grado di protezione IP67. Schermo di protezione in vetro trasparente temperato di spessore 10mm con resistenza meccanica IK 10 per passaggio veicolare. Guarnizione in gomma al silicone. Ottica fissa o orientabile. Equipaggiato con LED di colore bianco 4000K o 3000K potenza 9W o con portalampada GU10. Fornito completo di driver integrato nella struttura e di cavo di collegamento H05RN-F 3x1mm².

Structure and closing ring made of AISI 304 stainless steel. IP67 protection degree. Protection shield made of transparent tempered glass with 10mm thickness and IK 10 shock resistance for vehicle passage use. Silicone rubber gasket. Fixed or adjustable optic. Equipped with one LED in 4000K or 3000K color temperature power 9W or with GU10 lampholder. Supplied with built-in driver and H05RN-F 3x1mm² connecting cable.

CE	IP67
LED	RG1
CRI 80/90	Driver incl.
L80 B10	Driveover Carrabile
50000H	Mac Adam 3
⏚	



ERA

D.
OPTIC
45°
1

OPTIC
24°
2

OPTIC
10°
3

X.
CRI80
5

CRI90
6

Y.
4000K
7

3000K
8

FISSO / FIXED

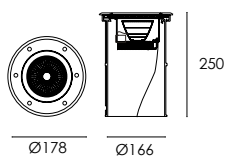

CODICE / CODE	D.MM	W	LM	DRIVER
FISSO / FIXED				
JEL.5540. D X Y	Ø178	13W/230V LED	2100/2000	built-in/incorporato

ACCESSORI / ACCESSORIES



JEL.FG
Vetro sabbiato
Sanded glass.



JEL.FR2
Cornice quadrata
Square ring.



AAA.CN3
Connettore IP68, 3vie.
IP68 waterproof connector, 3way.



AAA.CN4
Connettore IP68, 4vie.
IP68 waterproof connector, 4way.



CE	IP67
LED	RG1
CRI 80/90	Driver incl.
L80 B10	Driveover Carrabile
50000H	Mac Adam 3
⏚	

DIANA

FISSO / FIXED

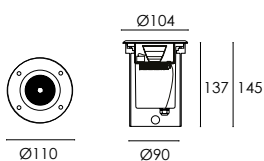

ORIENTABILE / ADJUSTABLE

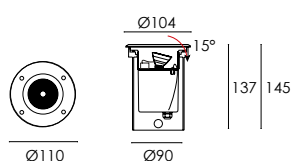

FISSO RGB / FIXED RGB

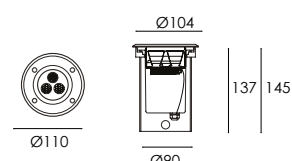

D.
OPTIC
36° 1

OPTIC
24° 2

OPTIC
12° 3

X.
CRI80
5

CRI90
6

Y.
4000K
7

3000K
8

2700K
9

CODICE / CODE	D.MM	W	LM	DRIVER
FISSO / FIXED				
JEO.5502. D X Y	Ø110	9W/230V LED	890/840/770	built-in/incorporato
JEO.35FGUB	Ø110	20W/230V GU10 lamp.	esclusa/lamp excluded	

CODICE / CODE	D.MM	W	LM	DRIVER
ORIENTABILE / ADJUSTABLE				
JEO.5503. D X Y	Ø110	9W/230V LED	890/840/770	built-in/incorporato
JEO.35MGUB	Ø110	20W/230V GU10 lamp.	esclusa/lamp excluded	

CODICE / CODE	D.MM	W	LM	FASCIO / BEAM	DRIVER
FISSO / FIXED					
JEO.5502.299	Ø110	6W/24V LED RGB	420	25°	excluded/escluso

ACCESSORI / ACCESSORIES



JEO.C1
Calottina a 1 finestra.
1 window dome.

JEO.C2
Calottina a 2 finestra.
2 windows dome.



JEO.FG
Vetro sabbato
Sanded glass.



JEO.FR2
Cornice quadrata
Square ring.



JEO.MS
Master JEO RGB.



JEO.SL
Slave JEO RGB.



AAA.CN3
Connettore IP68, 3vie.
IP68 waterproof connector, 3way.

AAA.CN4
Connettore IP68, 4vie.
IP68 waterproof connector, 4way.

CALPESTABILI WALKABILI



Serie di incassi a terra di Civic ispirati all'analogia serie carrabile. L'abbinamento di estetica e performance rendono questa collezione particolarmente adatta ove la fonte luminosa diventi elemento di design. La famiglia è realizzata interamente in acciaio Inox offrendo resistenza e durata nel tempo.

This family of ground recessed fittings is inspired by the similar drive over-one. Performance and aesthetics makes this range suitable where the light source needs to be installed in a design contest. The construction entirely in Stainless steel ensure reliability and quality along the time.

Eric
David
Zante



Calpestabili



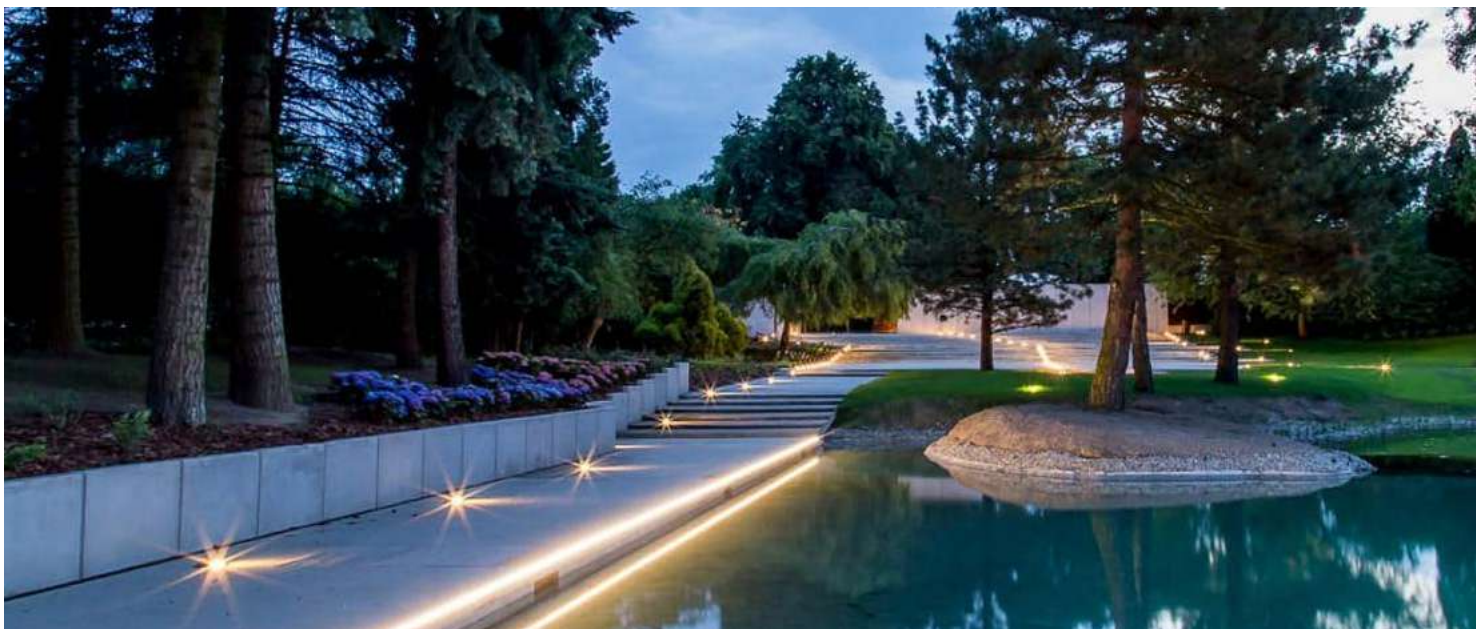

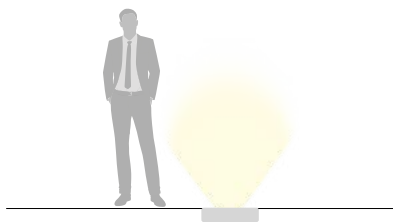

ZANTE

Corpo e anello di chiusura in acciaio inox AISI 304. Grado di protezione IP67. Schermo di protezione in vetro trasparente temperato di spessore 12mm con resistenza meccanica IK 10 per passaggio pedonale. Guarnizione in gomma al silicone. Riflettore fisso asimmetrico o orientabile. Equipaggiato con un LED di colore bianco 4000K o 3000K. Potenze da 17W a 24W. Fornito completo di driver integrato nella struttura e di cavo di collegamento H05RN-F 3x1mm².

Structure and closing ring made of AISI 304 stainless steel. IP67 protection degree. Protection shield made of transparent tempered glass with 12mm thickness and IK 10 shock resistance for walk-over use. Silicone rubber gasket. Fixed, asymmetric or adjustable reflector. Equipped with one LED in 4000K or 3000K color temperature. Power from 17W up to 24W. Supplied with built-in driver and H05RN-F 3x1mm² connecting cable.

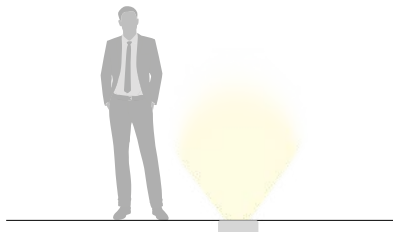

ERIC

Corpo e anello di chiusura in acciaio inox AISI 304. Grado di protezione IP67. Schermo di protezione in vetro trasparente temperato di spessore 10mm con resistenza meccanica IK 10 per passaggio pedonale. Guarnizione in gomma al silicone. Equipaggiato con un LED di colore bianco 4000K o 3000K. Potenza 13W. Fornito completo di driver integrato nella struttura e di cavo di collegamento H05RN-F 3x1mm².

Structure and closing ring made of AISI 304 stainless steel. IP67 protection degree. Protection shield made of transparent tempered glass with 10mm thickness and IK 10 shock resistance for walk-over use. Silicone rubber gasket. Fixed reflector. Equipped with one LED in 4000K or 3000K color temperature. Power 13W. Supplied with built-in driver and H05RN-F 3x1mm² connecting cable.

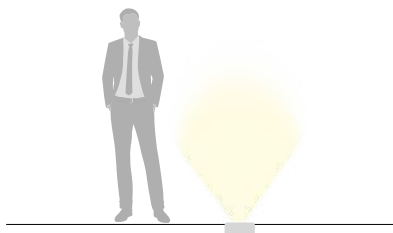

DAVID

Corpo e anello di chiusura in acciaio inox AISI 304. Grado di protezione IP67. Schermo di protezione in vetro trasparente temperato di spessore 10mm con resistenza meccanica IK 10 per passaggio pedonale. Guarnizione in gomma al silicone. Ottica fissa o orientabile. Equipaggiato con LED di colore bianco 4000K o 3000K potenza 9W o con portalampada GU10. Fornito completo di driver integrato nella struttura e di cavo di collegamento H05RN-F 3x1mm².

Structure and closing ring made of AISI 304 stainless steel. IP67 protection degree. Protection shield made of transparent tempered glass with 10mm thickness and IK 10 shock resistance for walk-over use. Silicone rubber gasket. Fixed or adjustable optic. Equipped with one LED in 4000K or 3000K color temperature power 9W or with GU10 lampholder. Supplied with built-in driver and H05RN-F 3x1mm² connecting cable.



CE	IP67
LED	RG1
CRI 80/90	Driver incl.
L80 B10	Mac Adam 3
50000H	⏚



ZANTE

D. OPTIC 38° 1	FISSO / FIXED		ORIENTABILE / ADJUSTABLE		ASIMMETRICO / ASYMMETRIC	
OPTIC 20° 2						
OPTIC 13° 3						
X. CRI80 5	FISSO / FIXED					
CRI90 6	ORIENTABILE / ADJUSTABLE					
Y. 4000K 7	ASIMMETRICO / ASYMMETRIC					
3000K 8						
	CODICE / CODE	D.MM	W	LM	DRIVER	
	ZNT.6580. D X Y	Ø260	24W/230V LED	3710/3550	built-in/incorporato	
	ZNT.6581. D X Y	Ø260	17W/230V LED	2700/2550	built-in/incorporato	
	ZNT.6582. 1 X Y	Ø260	24W/230V LED	3700/3550	built-in/incorporato	

ACCESSORI / ACCESSORIES



ZNT.FG
Vetro sabbato
Sanded glass.



AAA.CN3
Connettore IP68, 3vie.
IP68 waterproof connector, 3way.



AAA.CN4
Connettore IP68, 4vie.
IP68 waterproof connector, 4way.



CE	IP67
LED	RG1
CRI 80/90	Driver incl.
L80 B10	Mac Adam 3
50000H	⏚

ERIC

FISSO / FIXED

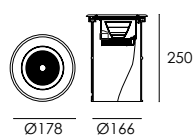

CODICE / CODE	D.MM	W	LM	DRIVER
FISSO / FIXED				
DEL.6540. D X Y	Ø178	13W/230V LED	2100/2000	built-in/incorporato

D.
OPTIC
45°
1

OPTIC
24°
2

OPTIC
10°
3

X.
CRI80
5

CRI90
6

Y.
4000K
7

3000K
8

ACCESSORI / ACCESSORIES



DEL.FG
Vetro sabbato
Sanded glass.



AAA.CN3
Connettore IP68, 3vie.
IP68 waterproof connector, 3way.



AAA.CN4
Connettore IP68, 4vie.
IP68 waterproof connector, 4way.

CE	IP67
LED	RG1
CRI 80/90	Driver incl.
L80 B10	Mac Adam 3
50000H	



DAVID

D. OPTIC 36° 1	FISSO / FIXED		ORIENTABILE / ADJUSTABLE		FISSO RGB / FIXED RGB	
X. CRI80 5	CODICE / CODE		D.MM	W	LM	DRIVER
Y. 4000K 7	FISSO / FIXED					
	DEO.6502. D X Y	Ø110	9W/230V LED	890/840/770	built-in/incorporato	
3000K 8	ORIENTABILE / ADJUSTABLE					
	DEO.6503. D X Y	Ø110	9W/230V LED	890/840/770	built-in/incorporato	
2700K 9	FISSO / FIXED					
	DEO.35FGU	Ø110	20W/230V GU10 lamp. esclusa/lamp excluded			
ORIENTABILE / ADJUSTABLE						
DEO.35MGU	Ø110	20W/230V GU10 lamp. esclusa/lamp excluded				
CODICE / CODE		D.MM	W	LM	FASCIO/BEAM	DRIVER
DEO.6502.299		Ø110	6W/24V LED	420	25°	excluded/escluso

ACCESSORI / ACCESSORIES



DEO.FG
Vetro sabbato
Sanded glass.



DEO.MS
Master DEO RGB.

DEO.SL
Slave DEO RGB.



AAA.CN3
Connettore IP68, 3vie.
IP68 waterproof connector, 3way.



AAA.CN4
Connettore IP68, 4vie.
IP68 waterproof connector, 4way.

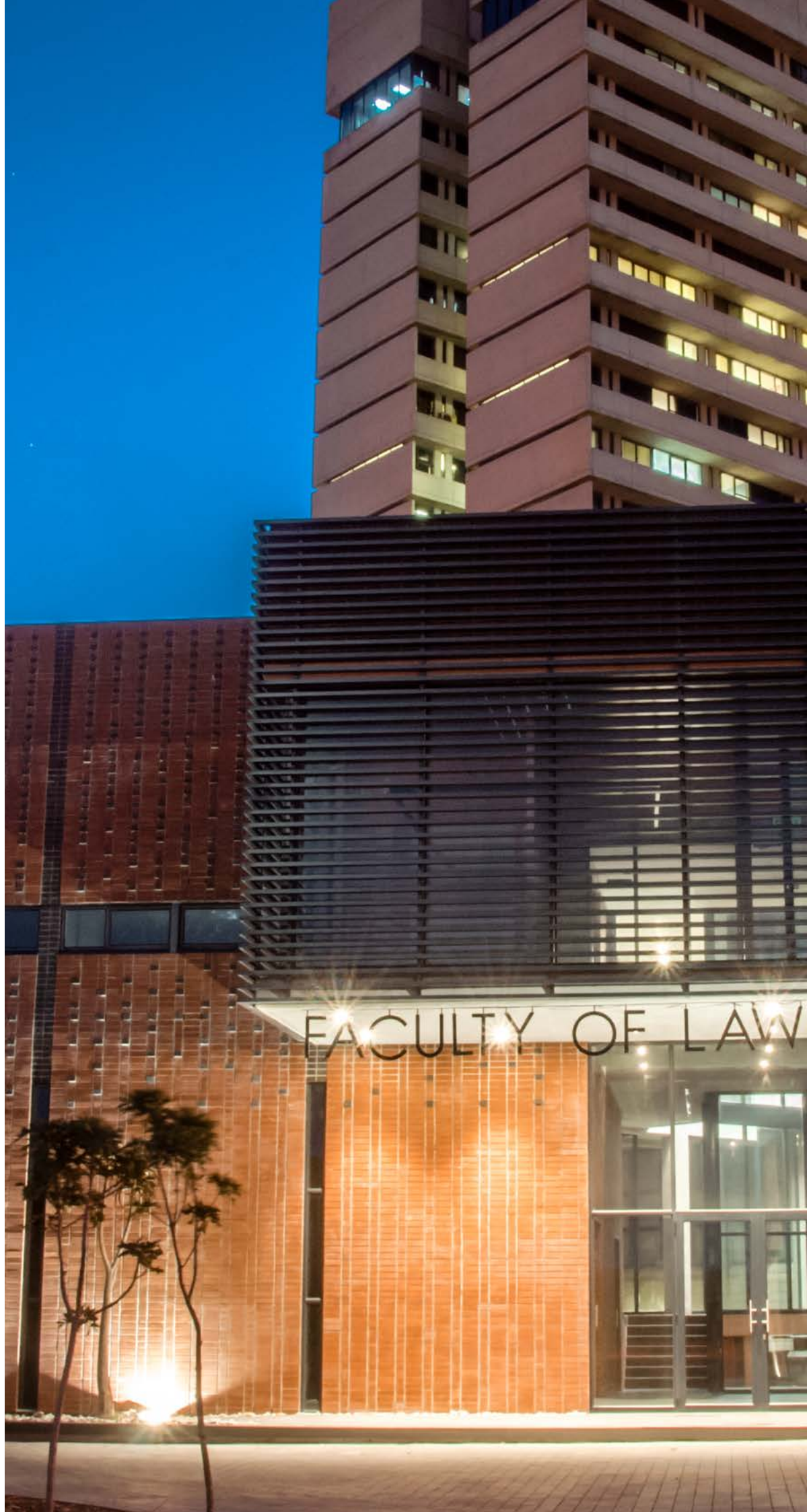

BOSS



Boss è un proiettore da esterno con corpo impermeabile alla pioggia e alle intemperie. Il suo design funzionale ed accattivante impedisce all'acqua e ad altro materiale di depositarsi sulla sommità dell'apparecchio. Grazie alla sua orientabilità, ampia gamma di ottiche e alta prestazione, Boss è ideale per applicazioni in molti spazi esterni come giardini, porticati, dehors e spazi domestici.

Boss is an outdoor spotlight with a rain- and weatherproof housing. Its functional and attractive design prevents water and other material from settling on top of the product.

Thanks to its adjustability, wide range of optics and high performance, Boss is ideal for applications in many outdoor spaces such as gardens, porches, patios and domestic spaces.



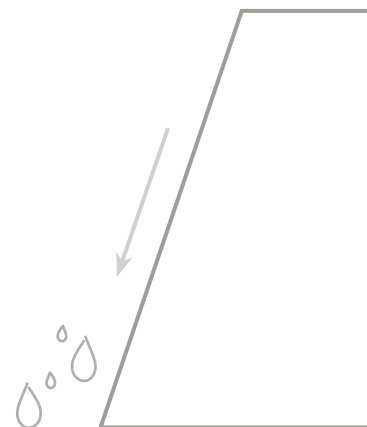

BOSS

Struttura e anello di chiusura orientabile in acciaio inox, vetro temperato infrangibile da 8 mm di spessore. Disponibile nelle versioni con ottica fissa LED e adatta ad ospitare lampade Gu10. L'anello di chiusura e la viteria sono in acciaio inox AISI 304L.

Body and orientable closure ring in stainless steel, tempered and shatterproof glass 8 mm thick. Available in fixed LED and Gu10 versions. The closing frame and screws are in stainless steel AISI 304L.

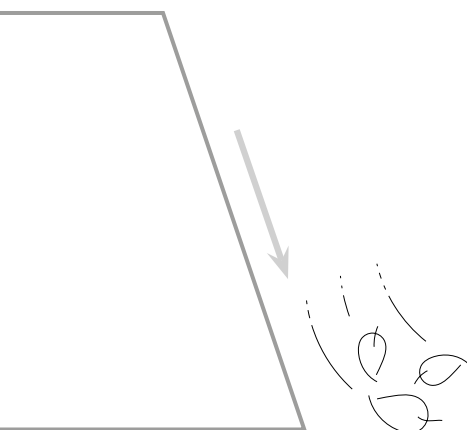

CE	IP65
LED	RG1
CRI 80/90	Driver incl.
L80 B10	Mac Adam 3
50000H	⏏



BOSS

D. OPTIC 36° 1	FISSO / FIXED		ORIENTABILE / ADJUSTABLE		DRIVER
	Ø110	150	Ø110	150	
OPTIC 24° 2	FISSO / FIXED		ORIENTABILE / ADJUSTABLE		DRIVER
OPTIC 12° 3	FISSO / FIXED		ORIENTABILE / ADJUSTABLE		
X. CRI80 5	FISSO / FIXED		ORIENTABILE / ADJUSTABLE		DRIVER
CRI90 6	FISSO / FIXED		ORIENTABILE / ADJUSTABLE		
Y. 4000K 7	FISSO / FIXED		ORIENTABILE / ADJUSTABLE		DRIVER
3000K 8	FISSO / FIXED		ORIENTABILE / ADJUSTABLE		
2700K 9	FISSO / FIXED		ORIENTABILE / ADJUSTABLE		DRIVER
	BEO.7502. D X Y	Ø110	9W/230V LED	890/840/770	
	BEO.35FGU	Ø110	20W/230V GU10 lamp. esclusa/lamp excluded		
	BEO.7503. D X Y	Ø110	9W/230V LED	890/840/770	built-in/incorporato
	BEO.35MGU	Ø110	20W/230V GU10 lamp. esclusa/lamp excluded		

ACCESSORI / ACCESSORIES



BEO.FG
Vetro sabbaiato
Sanded glass.



AAA.CN3
Connettore IP68, 3vie.
IP68 waterproof connector, 3way.



AAA.CN4
Connettore IP68, 4vie.
IP68 waterproof connector, 4way.

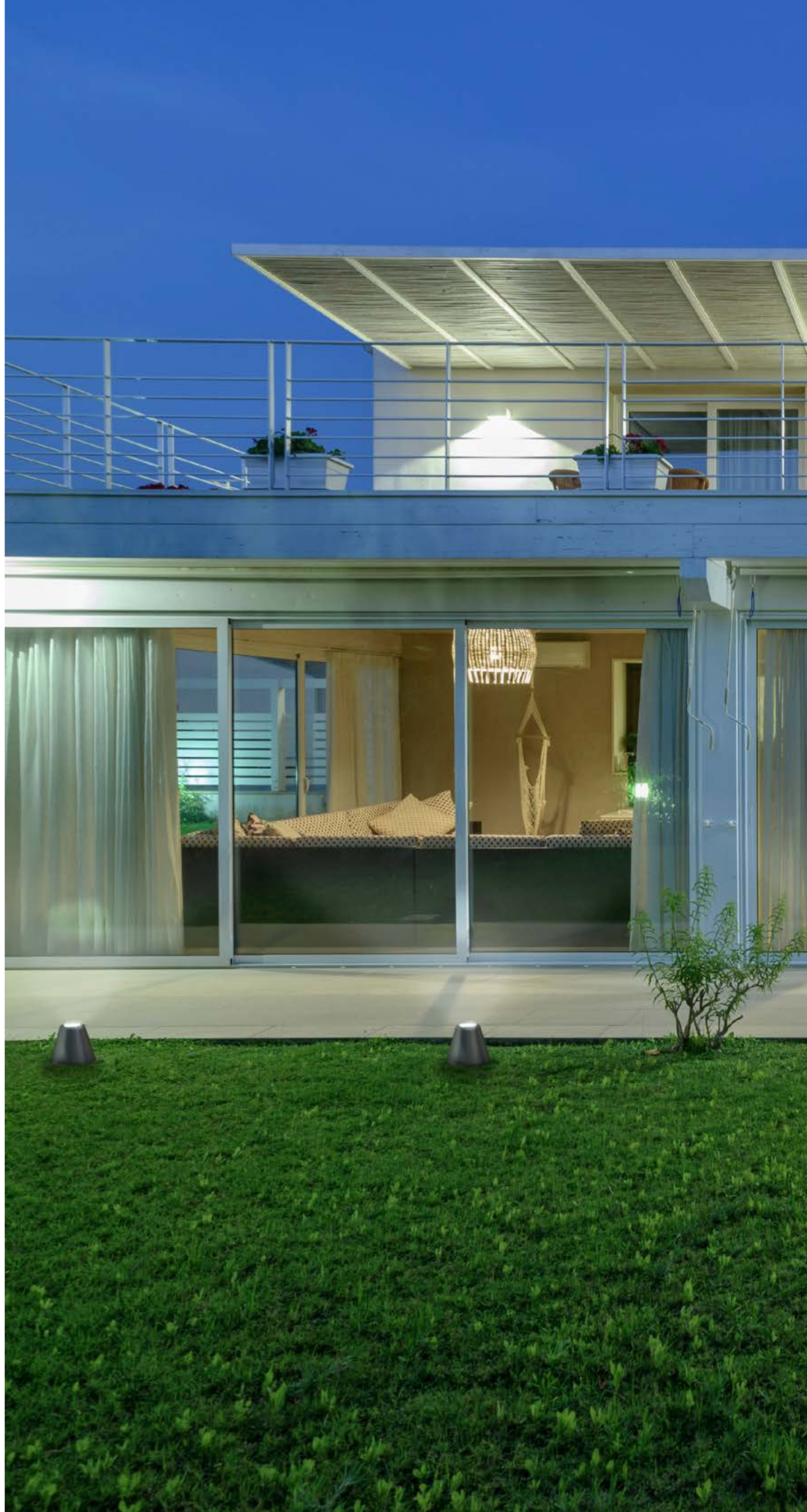

RAGGIO



Raggio è la famiglia "minimal" della gamma di prodotti da esterno Civic, caratterizzata da forme arrotondate e design essenziale. Non solo l'estetica dell'apparecchio, ma anche i coni e i tagli radenti di luce prodotti risultano di grande effetto. Raggio viene offerto in tre versioni per soddisfare le più diverse esigenze di illuminazione sia residenziale che architettonica.

Raggio is the "minimal" choice of the Civic outdoor range, characterized by shaped forms and essential design. Not only the aesthetics of the luminaire, but also the cones and grazing cuts of light produced are highly impressive. Raggio is offered in three different versions to meet the most different both residential and architectural lighting needs.



Raggio Side
Raggio Up

Scopri anche / look at:

Raggio Spot

pag. 104

Paletti & proiettori

Poles & bollards



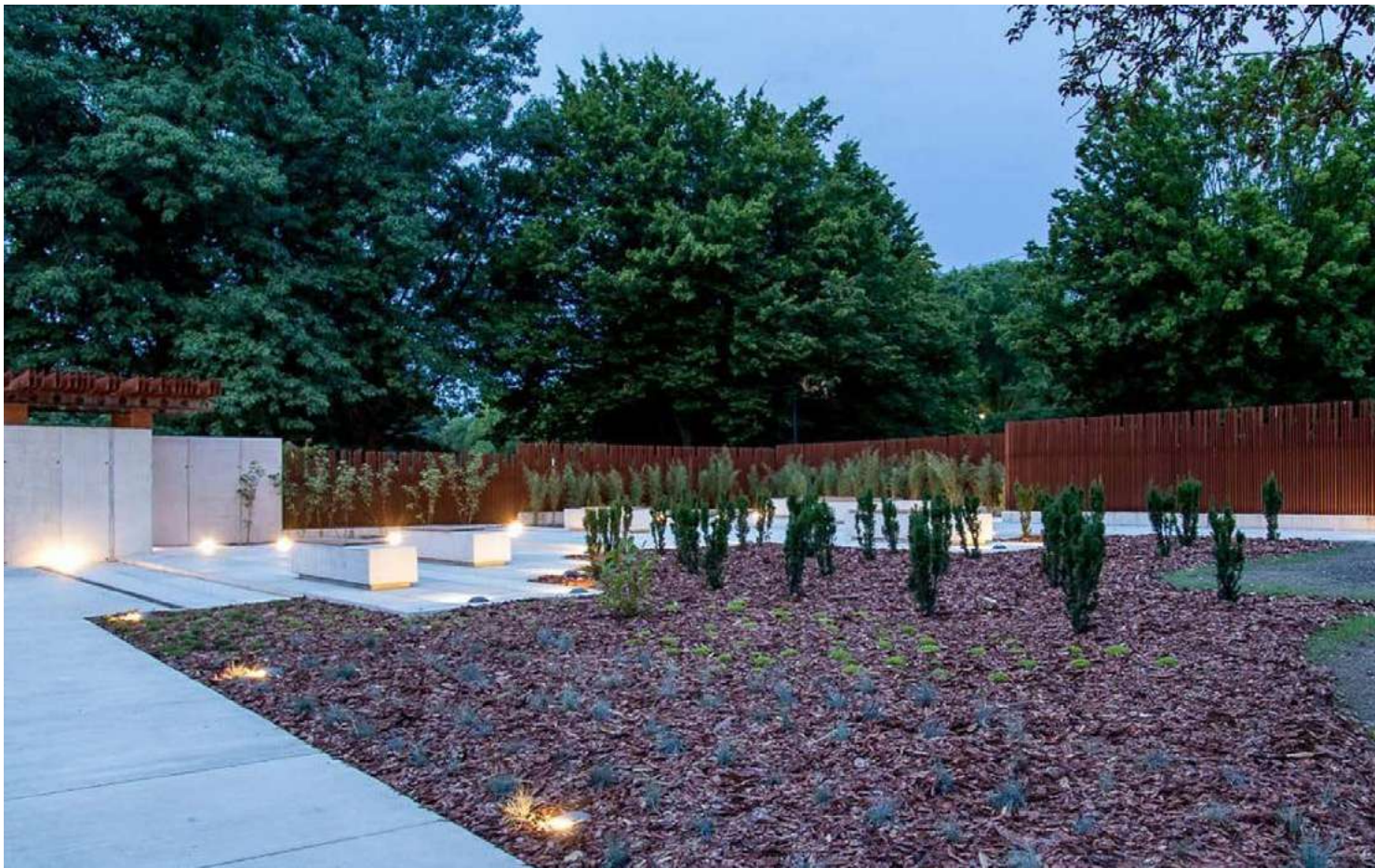



RAGGIO SIDE

Corpo e anello di chiusura in lega di alluminio sottoposti a pre-trattamento di anodizzazione galvanica. Grado di protezione IP67. Calotta pressofusa in lega di alluminio, vetro temperato sagomato per una ottimale diffusione luminosa. Equipaggiato con un LED di colore bianco 4000K o 3000K da alimentare con trasformatore in corrente costante da cablare in serie. Potenze da 1.2W a 2.4W. Fornito completo di cavo di collegamento H05RN-F 2x1mm².

Body and closing ring in aluminum alloy with galvanic anodizing pre-treatment. IP67 protection degree. Die cast aluminum cover, Protection shield made of shaped tempered glass. IK 10 shock resistance for vehicle passage use. Equipped with one LED in 4000K or 3000K color to be supplied with constant current driver (serial connection). Power from 1.2W up to 2.4W. Supplied with H05RN-F 2x1mm² connecting cable.



RAGGIO UP

Corpo e anello di chiusura in lega di alluminio sottoposti a pre-trattamento di anodizzazione galvanica. Grado di protezione IP67. Schermo di protezione in vetro trasparente temperato di spessore 10mm con resistenza meccanica IK 10 per passaggio veicolare. Equipaggiato con un LED di colore bianco 4000K o 3000K da alimentare con trasformatore in corrente costante da cablare in serie. Potenze da 1.2W a 2.4W. Fornito completo di cavo di collegamento H05RN-F 2x1mm².

Body and closing ring in aluminum alloy with galvanic anodizing pre-treatment. IP67 protection degree. Protection shield made of transparent tempered glass with 10mm thickness and IK 10 shock resistance for vehicle passage use. Equipped with one LED in 4000K or 3000K color to be supplied with constant current driver (serial connection). Power from 1.2W up to 2.4W. Supplied with H05RN-F 2x1mm² connecting cable.

CE	IP67
LED	RG1
CRI 80	Mac Adam 3
L80 B10	
50000H	



RAGGIO SIDE

Z. COLOR grigio metallizzato / metallic grey - 50

- CRIB8**
5
- 4000K**
7
- 3000K**
8

MONODIREZIONALE / MONO DIRECTIONAL

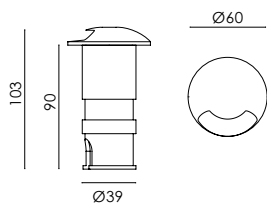

BIDIREZIONALE / BI DIRECTIONAL

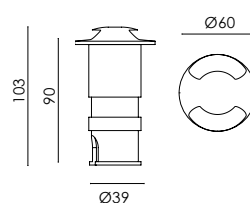

CODICE / CODE	D.MM	W	K	RING	DRIVER
MONODIREZIONALE / MONO DIRECTIONAL					
LAA.5101.8 5 7. Z	Ø60	1x1.2W/2.4	350/700mA	4000	1 window escluso/excluded
LAA.5101.8 5 8. Z	Ø60	1x1.2W/2.4	350/700mA	3000	1 window escluso/excluded
BIDIREZIONALE / BI DIRECTIONAL					
LAA.5101.9 5 7. Z	Ø60	1x1.2W/2.4	350/700mA	4000	2 windows escluso/excluded
LAA.5101.9 5 8. Z	Ø60	1x1.2W/2.4	350/700mA	3000	2 windows escluso/excluded

ACCESSORI / ACCESSORIES



AAA.TRSL00
Driver IP20 3W/350mA.



AAA.TRSL41
Driver IP20 6W/500mA.



AAA.TRSL30
Driver IP20 3W/700mA.



AAA.TRSL45
Driver IP20 20W/500mA.

AAA.TRSL05
Driver IP20 19W 350/700 mA.



CE	IP67
LED	RG1
CRI 80	Mac Adam 3
L80 B10	III
50000H	

50 - grigio metallizzato / metallic grey

Z. COLOR

RAGGIO UP

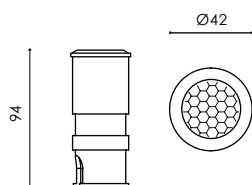

D. OPTIC 15° 1

OPTIC 60° 4

CRIB0 5

4000K 7

3000K 8

CODICE / CODE	D.MM	W	K	DRIVER
LAA.5101.D 5 7. Z	Ø42	1x1.2W/2.4 350/700mA	4000	escluso/excluded
LAA.5101.D 5 8. Z	Ø42	1x1.2W/2.4 350/700mA	3000	escluso/excluded

ACCESSORI / ACCESSORIES



AAA.TRSL00
Driver IP20 3W/350mA.



AAA.TRSL41
Driver IP20 6W/500mA.



AAA.TRSL30
Driver IP20 3W/700mA.

AAA.TRSL05
Driver IP20 19W 350/700 mA.



AAA.TRSL45
Driver IP20 20W/500mA.

Indoor INTERNI

INTERNI indoor

INTERNI INDOOR

INDOOR INTER

INDOOR INDO

INTERNI INTERNI

INDOOR inter

INTERNI INDOOR

INDOOR INTER

INTERNI Indoor

OR INDOOR IN

NI Indoor INTER

OR **INTERNI** IND

NI INDOOR INTER

ni Indoor INTERN

OR INTERNI inte

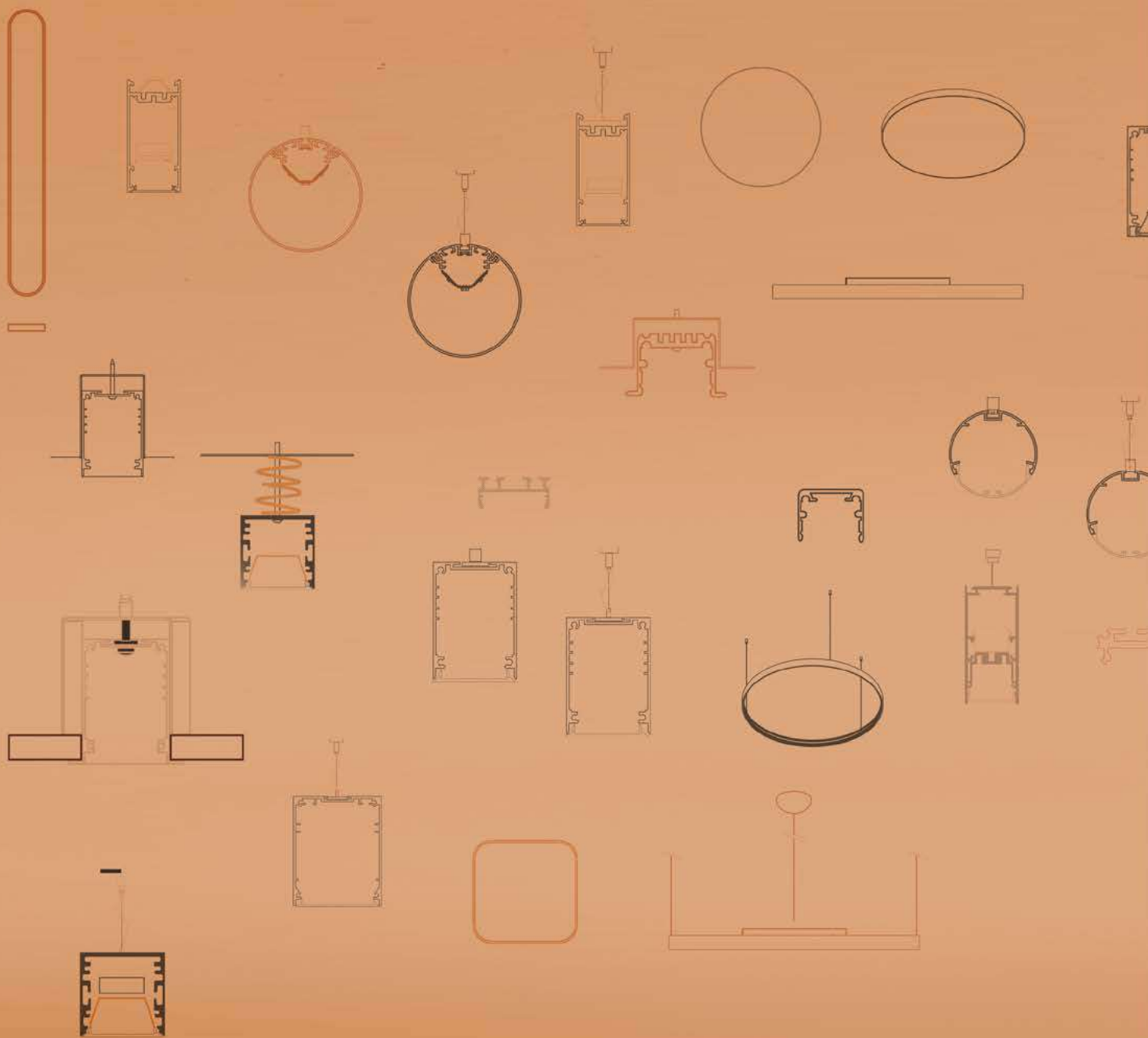

SISTEMI LINEARI

Lighting system

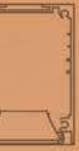

Indoor

MINU - R

Square Lap



Minu-R è una collezione di anelli decorativi luminosi a luce diretta o a luce interna. Design elegante e leggero ma di grande impatto scenico, è ideale per uffici, contesti residenziali e commerciali.

Minu-R is a collection of decorative lighting rings with direct or internal light. It can offer such elegant and light design, with great scenic impact ; it is the ideal choice for offices, residential and commercial environments.



Diffuser Perimeter

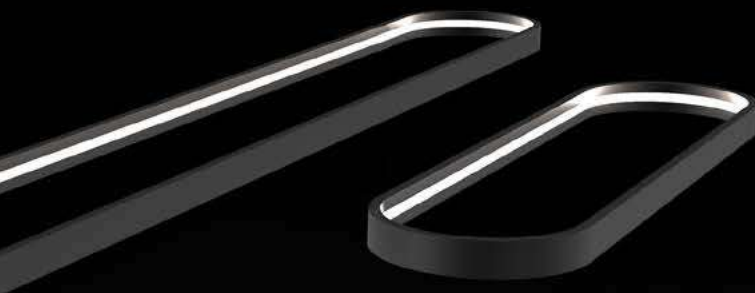
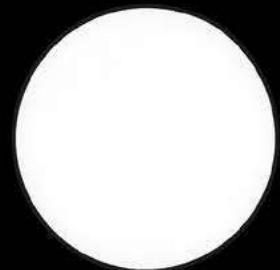



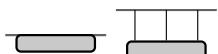

MINU-R DIFFUSER

Realizzati in lega di alluminio estruso curvato verniciato a polveri con schermo di protezione in policarbonato. Tono bianco, 4000K o 3000K. Potenze da 60W/560mm a 198W/1120mm. Accessori per la sospensione da ordinare separatamente. Alimentatore on-off o DALI incluso.

Structure in powder coated curved extrusion of aluminium alloy with opal diffuser. 4000K or 3000K white tone. Powers from 60W/560mm up to 198W/1120mm. Suspension kit to be ordered separately. On-Off or Dali Driver included



MINU-R PERIMETER

Realizzati in lega di alluminio estruso curvato verniciato a polveri con schermo di protezione in policarbonato. Tono bianco, 4000K o 3000K. Potenze da 30W/560mm a 110W/1480mm. Accessori per la sospensione da ordinare separatamente. Alimentatore on-off o DALI incluso nel rosone.

Structure in powder coated curved extrusion of aluminium alloy with opal diffuser. 4000K or 3000K white tone. Powers from 30W/560mm up to 110W/1480mm. Suspension kit to be ordered separately. On-Off or Dali Driver included in the ceiling cup.

CE	IP40
LED	RG1
CRI 80/90	Driver incl.
L80 B10	Mac Adam 3
	50000H



MINU - R

DIFFUSER

Z.
COLOR

bianco raggrinzante/rough white -32

nero raggrinzante/rough black -33

custom -99

D.
OPAL
1

MICRO
PRISMATIC
9

X.
CRI80
5

CRI90
6

Y.
4000K
7

3000K
8

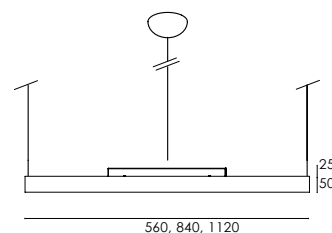
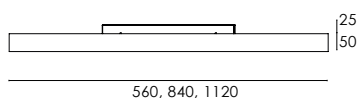
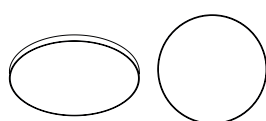

CODICE / CODE

D.MM

W

LM

CODICE / CODE	D.MM	W	LM
MNU.5625. D X Y. Z	560	60W/230V LED	8500/8300
MNU.5626. D X Y. Z	840	124W/230V LED	17000/16600
MNU.5627. D X Y. Z	1120	198W/230V LED	27300/27000

ACCESSORI / ACCESSORIES



MNU.SD1

Kit di sospensione L.2000mm.
Suspension kit L.2000mm.



CE	IP40
LED	RG1
CRI 80/90	Mac Adam 3
L80 B10	50000H

- 32- bianco raggrinzante/rough white
- 33- nero raggrinzante/rough black
- 99- custom

Z.
COLOR

MINU - R

PERIMETER

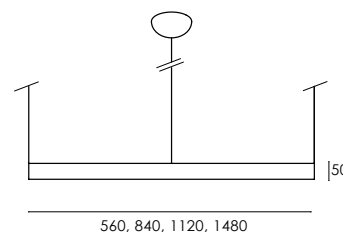
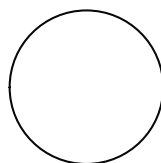
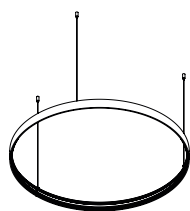

CODICE / CODE

D.MM

W

LM

MNU.5635. 1 X Y. Z	560	30W/230V LED	3010/2630
MNU.5636. 1 X Y. Z	840	50W/230V LED	4520/3950
MNU.5637. 1 X Y. Z	1120	70W/230V LED	6020/5270
MNU.5638. 1 X Y. Z	1480	110W/230V LED	9460/9100

- OPAL 1
- X. CRI80 5
- CRI90 6
- Y. 4000K 7
- 3000K 8

ACCESSORI / ACCESSORIES



MNU.SP1
Kit di sospensione L.2000mm e driver 50W.
Suspension kit L.2000mm and driver 50W.



MNU.SP3
Kit di sospensione L.2000mm e driver 110W.
Suspension kit L.2000mm and driver 110W.



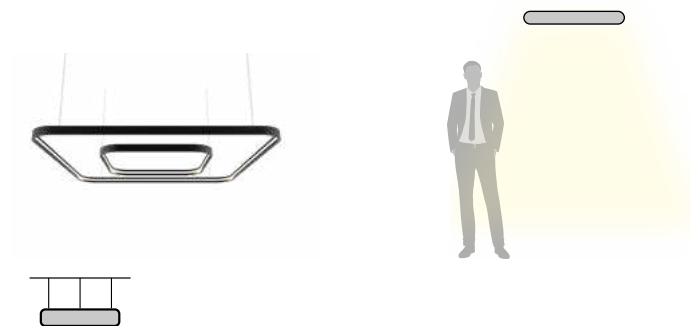

MINU-R SQUARE

Realizzati in lega di alluminio estruso curvato verniciato a polveri con schermo di protezione in policarbonato. Tono bianco, 4000K o 3000K, Potenze da 55W/750mm a 110W/1500mm. Accessori per la sospensione da ordinare separatamente. Alimentatore on-off o DALI incluso nel rosone.

Structure in powder coated curved extrusion of aluminium alloy with opal diffuser. 4000K or 3000K white tone. Powers from 55W/560mm up to 110W/1500mm. Suspension kit to be ordered separately. On-Off or Dali Driver included in the ceiling cup.



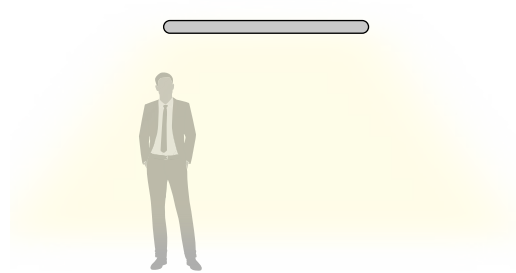

MINU-R LAP

Realizzati in lega di alluminio estruso curvato verniciato a polveri con schermo di protezione in policarbonato. Tono bianco, 4000K o 3000K, Potenze da 50W/1150mm a 95W/2300mm. Accessori per la sospensione da ordinare separatamente. Alimentatore on-off o DALI incluso nel rosone.

Structure in powder coated curved extrusion of aluminium alloy with opal diffuser. 4000K or 3000K white tone. Powers from 50W/1150mm up to 95W/2300mm. Suspension kit to be ordered separately. On-Off or Dali Driver included in the ceiling cup.

CE	IP40
LED	RG1
CRI 80/90	50000H
L80 B10	Mac Adam 3



MINU - R

S Q U A R E

Z.
COLOR

bianco raggrinzante/rough white -32

nero raggrinzante/rough black -33

custom -99

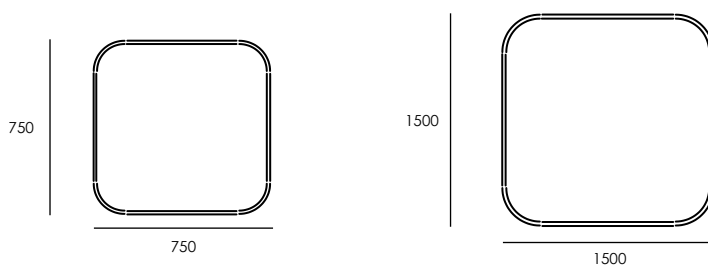

	CODICE / CODE	L.MM	W	LM
OPAL 1				
X. CRI80 5	MNU.5646. 1 X Y. Z	750	55W/230V LED	4972/4345
	MNU.5648. 1 X Y. Z	1500	110W/230V LED	9460/9100
CRI90 6				
Y. 4000K 7				
3000K 8				

ACCESSORI / ACCESSORIES



MNU.SQ1
Kit di sospensione L.2000mm
e driver 55W.
Suspension kit L.2000mm and
driver 55W.



MNU.SQ3
Kit di sospensione L.2000mm
e driver 110W.
Suspension kit L.2000mm and
driver 110W.



CE	IP40
LED	RG1
CRI 80/90	50000H
L80 B10	Mac Adam 3

- 32- bianco raggrinzante/rough white
- 33- nero raggrinzante/rough black
- 99- custom

Z.
COLOR

MINU - R

L A P

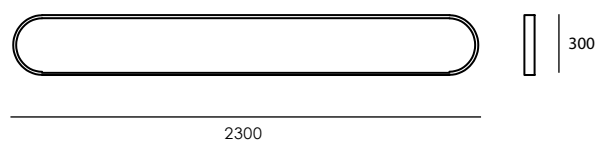
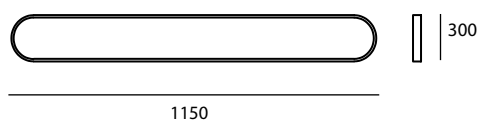

CODICE / CODE	L.MM	W	LM
MNU.5656. 1 X Y. Z	1150	50W/230V LED	4520/3950
MNU.5659. 1 X Y. Z	2300	95W/230V LED	8170/7860

OPAL
1

X.
CRI80
5

CRI90
6

Y.
4000K
7

3000K
8

ACCESSORI / ACCESSORIES



MNU.SL1
Kit di sospensione L.2000mm
e driver 50W.
Suspension kit L.2000mm and
driver 50W.



MNU.SL3
Kit di sospensione L.2000mm
e driver 95W.
Suspension kit L.2000mm and
driver 95W.

SHADOW

Profilo dalle linee sobrie e discrete, è adatto ad illuminare uffici ed ambienti di lavoro. Nella versione a luce diretta ed indiretta è la soluzione ideale per creare un ambiente accogliente dai toni più morbidi e sfumati.

Profile with sober and discreet lines, it is suitable for lighting offices and work environments. In the direct and indirect light version it is the ideal solution to create a welcoming environment with softer and more nuanced tones.

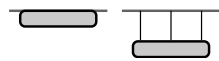
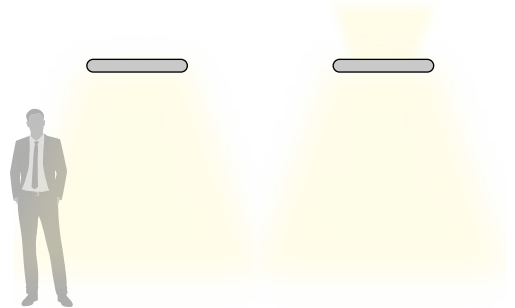
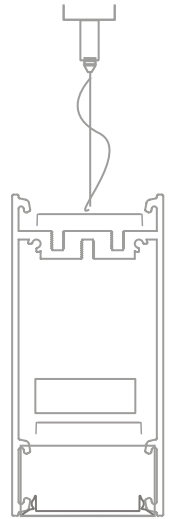

SHADOW

Sistema modulare in alluminio estruso da plafone o sospensione. Driver e diffusore opale o microprismato inclusi. Accessori da ordinare separatamente.

Modular system in extruded aluminium for ceiling or suspended installation. Driver and opal or microprismatic diffuser included. Accessories to be ordered separately.

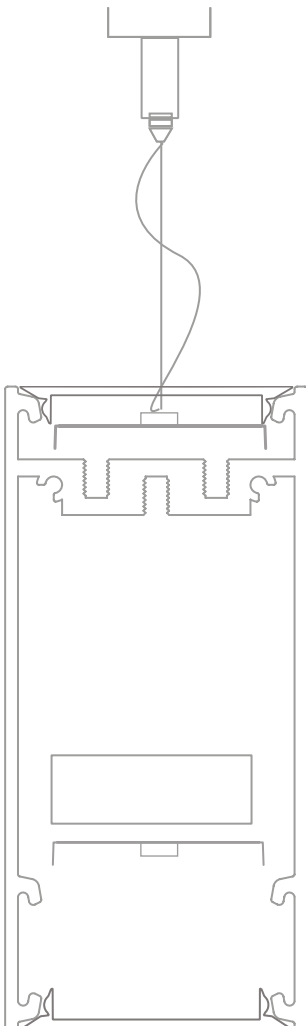

CE	IP20
LED	RG1
CRI 80/90	Driver incl.
L80 B10	Mac Adam 3
	50000H

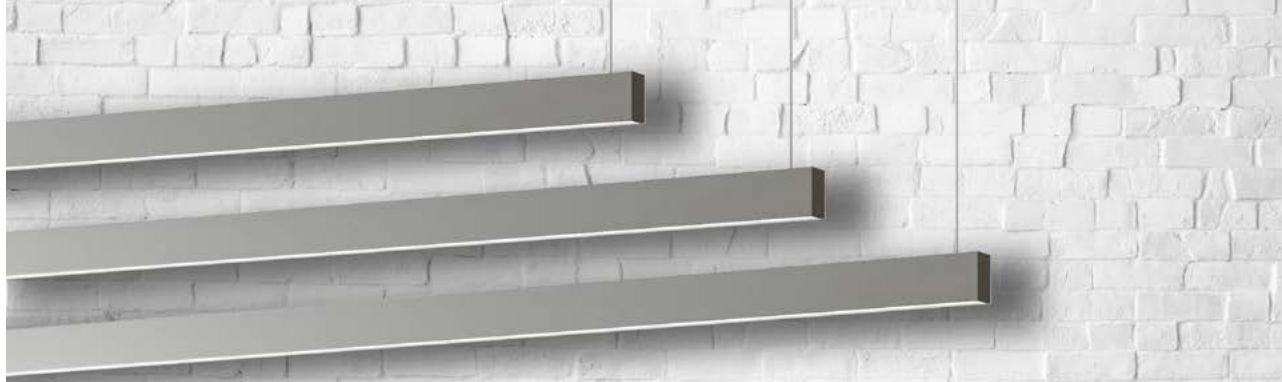

SHADOW

Z.
COLOR

bianco/white -02

nero/black -03

custom -99

D.
OPAL
0

MICRO
PRISMATIC
9

X.
CRI80
5

CRI90
6

Y.
5000K
6

4000K
7

3000K
8

DIM.
1-10V
A1

DALI
A2

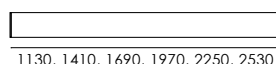
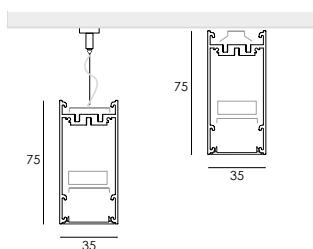

CODICE / CODE	L.MM	W	LM
DIRETTA/DIRECT			
LSA.4753.D X Y. Z	1130	28W/230V LED	3920/3820/3620
LSA.4754.D X Y. Z	1410	35W/230V LED	4910/4780/4540
LSA.4755.D X Y. Z	1690	42W/230V LED	5880/5730/5430
LSA.4756.D X Y. Z	1970	49W/230V LED	6870/6690/6350
LSA.4757.D X Y. Z	2250	56W/230V LED	7840/7640/7240
LSA.4758.D X Y. Z	2530	63W/230V LED	8830/8600/8160
DIRETTA.INDIRETTA/DIRECT.INDIRECT			
LSA.4853.D X Y. Z	1130	42W/230V LED	5880/5730/5430
LSA.4854.D X Y. Z	1410	49W/230V LED	6870/6690/6350
LSA.4855.D X Y. Z	1690	63W/230V LED	8830/8600/8160
LSA.4856.D X Y. Z	1970	77W/230V LED	10790/10510/10860
LSA.4857.D X Y. Z	2250	84W/230V LED	11760/11460/11320
LSA.4858.D X Y. Z	2530	91W/230V LED	12750/12420/11780

ACCESSORI / ACCESSORIES



LSA.TE
Testata di chiusura.
End cap.



LSA.CD
Giunto lineare.
Linear joint.



LSA.SO
Sospensioni (coppia).
Suspension kit (pair).



AAA.RA2
Rosone alimentato basic.
Power supply basic.



LSA.DP
Attacco plafone (coppia).
Ceiling bracket (pair).



ULISSE

Ulisse è un profilo tubolare da interni con effetto luminoso ininterrotto dal design pulito e minimale. Adatto all'illuminazione di ampi spazi domestici, lavorativi e architettonici. Permette un'ottimale diffusione della luce a file singole e continue.

Ulisse is a tubular profile for interiors with an uninterrupted lighting effect with a clean and minimal design. Suitable for lighting large domestic, work and architectural spaces. It allows an optimal diffusion of light in single and continuous rows.

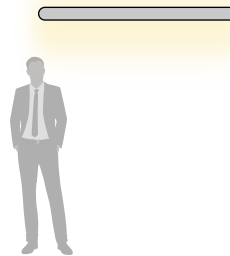
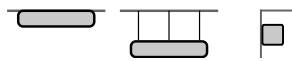

ULISSE

Plafoniera tubolare per installazione a soffitto o a sospensione. Corpo in alluminio estruso verniciato a polvere. Diffusore opale. Diffusore microprismato su richiesta (come opzione per controllo antiabbagliamento). Le versioni dimmerabili sono disponibili su richiesta.

Tubular system for ceiling or suspended installation. Body made in powder coated extruded aluminium. Opal diffuser. Microprismatic diffuser on demand (as an option for anti-glare control). Dimmable versions are available on demand.



CE	IP20
LED	RG1
CRI 80/90	Driver incl.
L80 B10	Mac Adam 3
	50000H

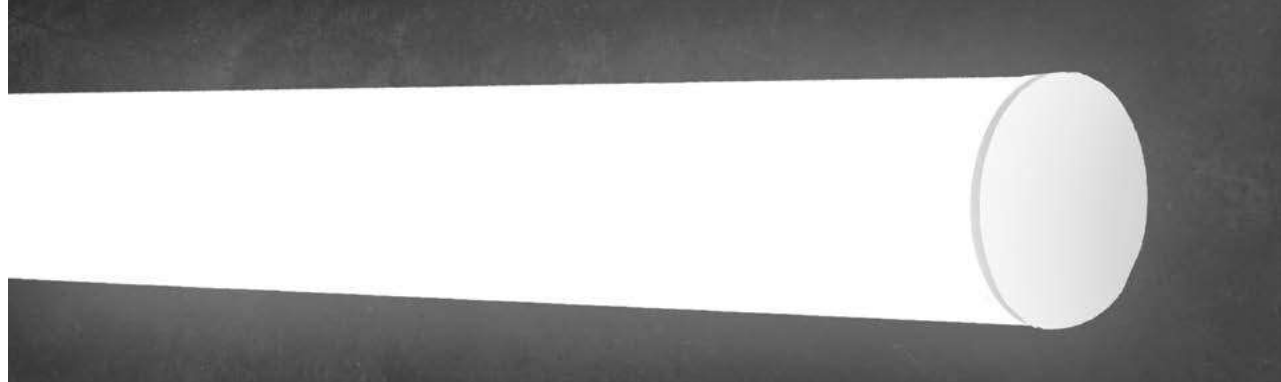

ULISSE

Z.
COLOR

bianco/white -02
custom -99

OPAL
0

X.
CRI80
5

CRI90
6

Y.
4000K
7

3000K
8

DIM.
1-10V
A1

DALI
A2

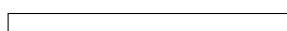
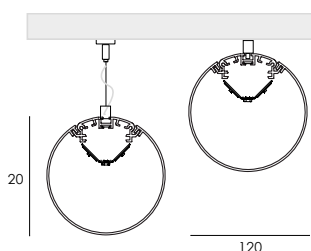

1130, 1410, 1690, 1970, 2250, 2530

CODICE / CODE	L.MM	W	LM
ULS.3363.0 X Y. Z	1130	56W/230V LED	7640/7240
ULS.3364.0 X Y. Z	1410	70W/230V LED	9560/9080
ULS.3365.0 X Y. Z	1690	84W/230V LED	11460/10860
ULS.3366.0 X Y. Z	1970	97W/230V LED	13380/12700
ULS.3367.0 X Y. Z	2250	112W/230V LED	15280/14480
ULS.3368.0 X Y. Z	2530	126W/230V LED	17200/16320

ACCESSORI / ACCESSORIES

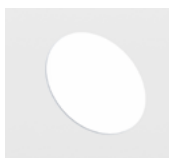

ULS.TE
Testata di chiusura.
End cap.



ULS.CD
Giunto lineare.
Linear joint.



ULS.AP
Attacco a parete e plafone
(coppia).
Wall bracket and ceiling(pair).



ULS.SO
Sospensioni (coppia).
Suspension kit (pair).



AAA.RA2
Rosone alimentato basic.
Power supply basic.



KPMG

SALES FORCE TO HABITS!

KPMG

MAKE THE SALES FORCE BE WITH YOU!

ROUND

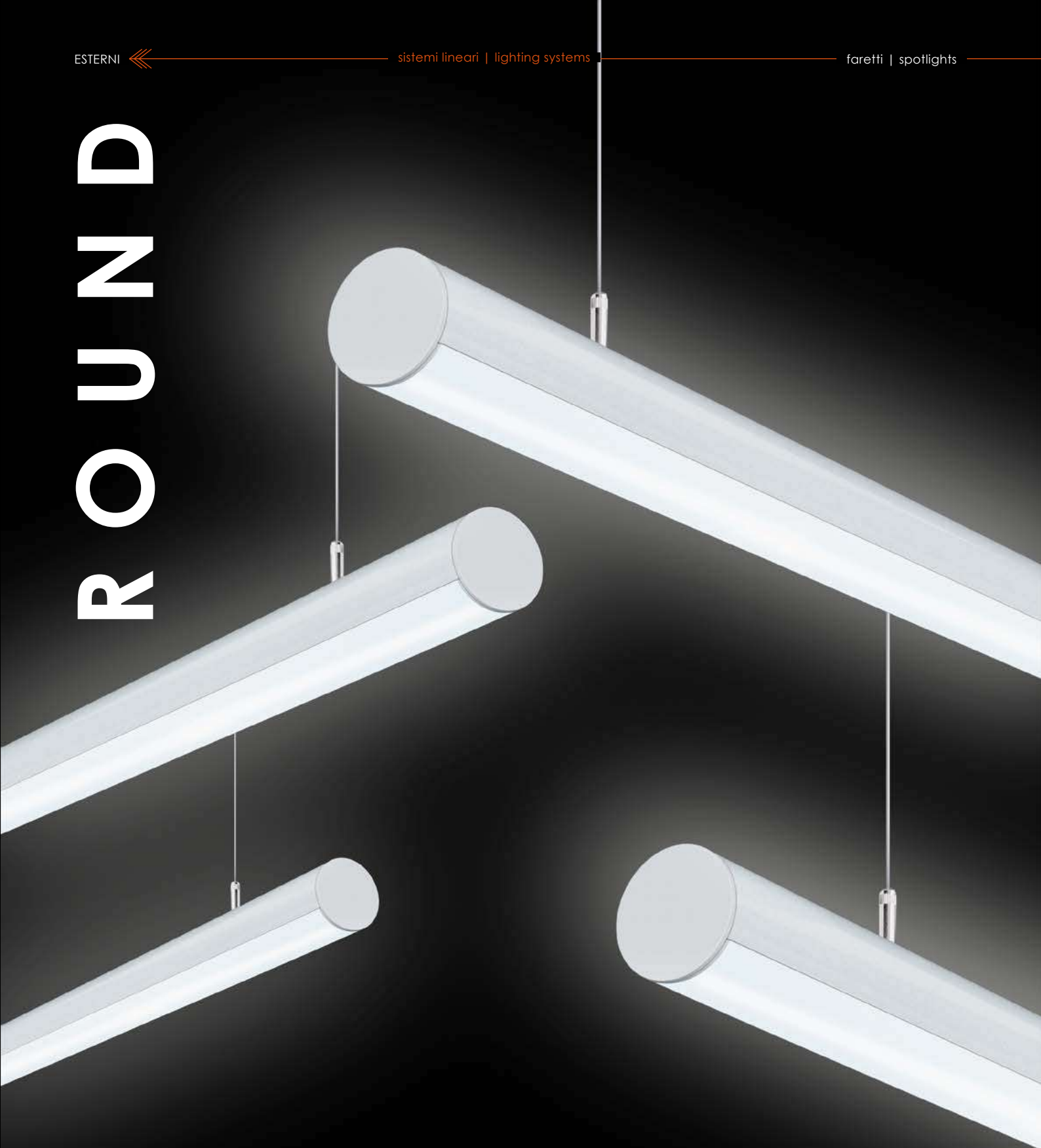

Profilo tubolare semplice e funzionale. Disponibile in diverse lunghezze per adattarsi ai diversi ambienti ed alle più svariate soluzioni di arredo. Pensato per l'ufficio trova la sua collocazione anche in ambienti domestici quali ingressi, corridoi e disimpegni.

Simple and functional tubular profile. Available in different lengths to adapt to different environments and to the most varied furnishing solutions. Designed for the office, it also finds its place in domestic environments such as entrances, corridors and corridors.

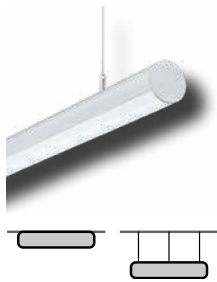

ROUND

Round è un apparecchio di illuminazione tubolare per interni installabile singolarmente o in file continue con un effetto luminoso ininterrotto.

Round is a tubular lighting fitting for indoor that can be installed alone or in continuous lines with an uninterrupted lighting effect.

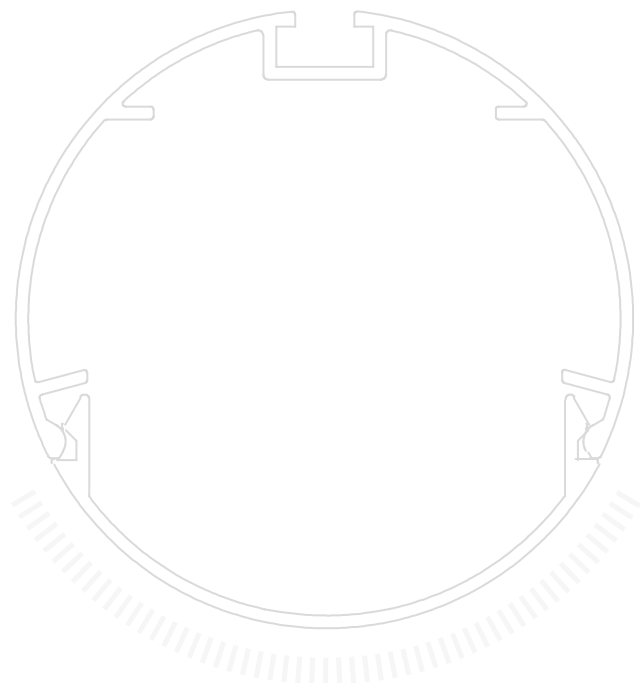



CE	IP20
LED	RG1
CRI 80/90	Driver incl.
L80 B10	Mac Adam 3
	50000H



ROUND

Z.
COLOR

bianco/white -02 
nero/black -03 
custom -99 

OPAL
0

X.
CRI80
5

CRI90
6

Y.
5000K
6

4000K
7

3000K
8

DIM.
1-10V
A1

DALI
A2

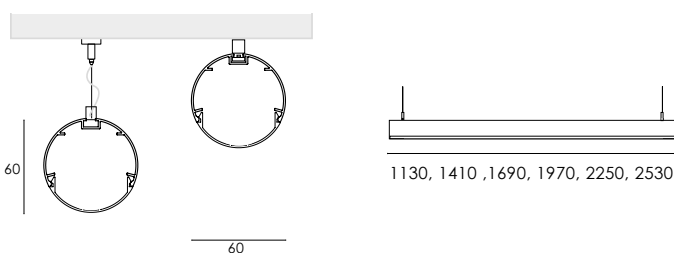

CODICE / CODE	L.MM	W	LM
F65.3613.0 X Y. Z	1130	28W/230V LED	3920/3820/3620
F65.3614.0 X Y. Z	1410	35W/230V LED	4910/4780/4540
F65.3615.0 X Y. Z	1690	42W/230V LED	5880/5730/5430
F65.3616.0 X Y. Z	1970	49W/230V LED	6870/6690/6350
F65.3617.0 X Y. Z	2250	56W/230V LED	7840/7640/7240
F65.3618.0 X Y. Z	2530	63W/230V LED	8830/8600/8160

ACCESSORI / ACCESSORIES



F65.TE
Testata di chiusura.
End cap.



F65.CD
Giunto lineare.
Linear joint.



AAA.SO
Sospensioni (coppia).
Suspension kit (pair).



AAA.RA2
Rosone alimentato basic.
Power supply basic.



TNI.DP
Attacco plafone (coppia).
Ceiling bracket (pair).



COCKTAIL

Cocktail Diffuser

Cocktail è un profilo d'illuminazione installabile singolarmente o in fila continua a plafone e sospensione dal design moderno e curato. Le molteplici lunghezze abbinante agli svariati fasci e diffusori lo rendono un sistema versatile e protagonista in diverse soluzioni d'arredo: la versione con ottiche a micro celle viene scelta laddove serve fascio controllato, mentre dove è necessaria un'illuminazione più estesa si predilige la versione con diffusore.

Cocktail is a family of LED linear lighting systems for single or continuous lines, for ceiling or suspended installation with a modern and refined design. The different lengths combined with the various beams and diffusers make it the ideal choice in different solutions: the micro-cell optic for the beam control, the diffuser version for general lighting.



Cocktail
UGR

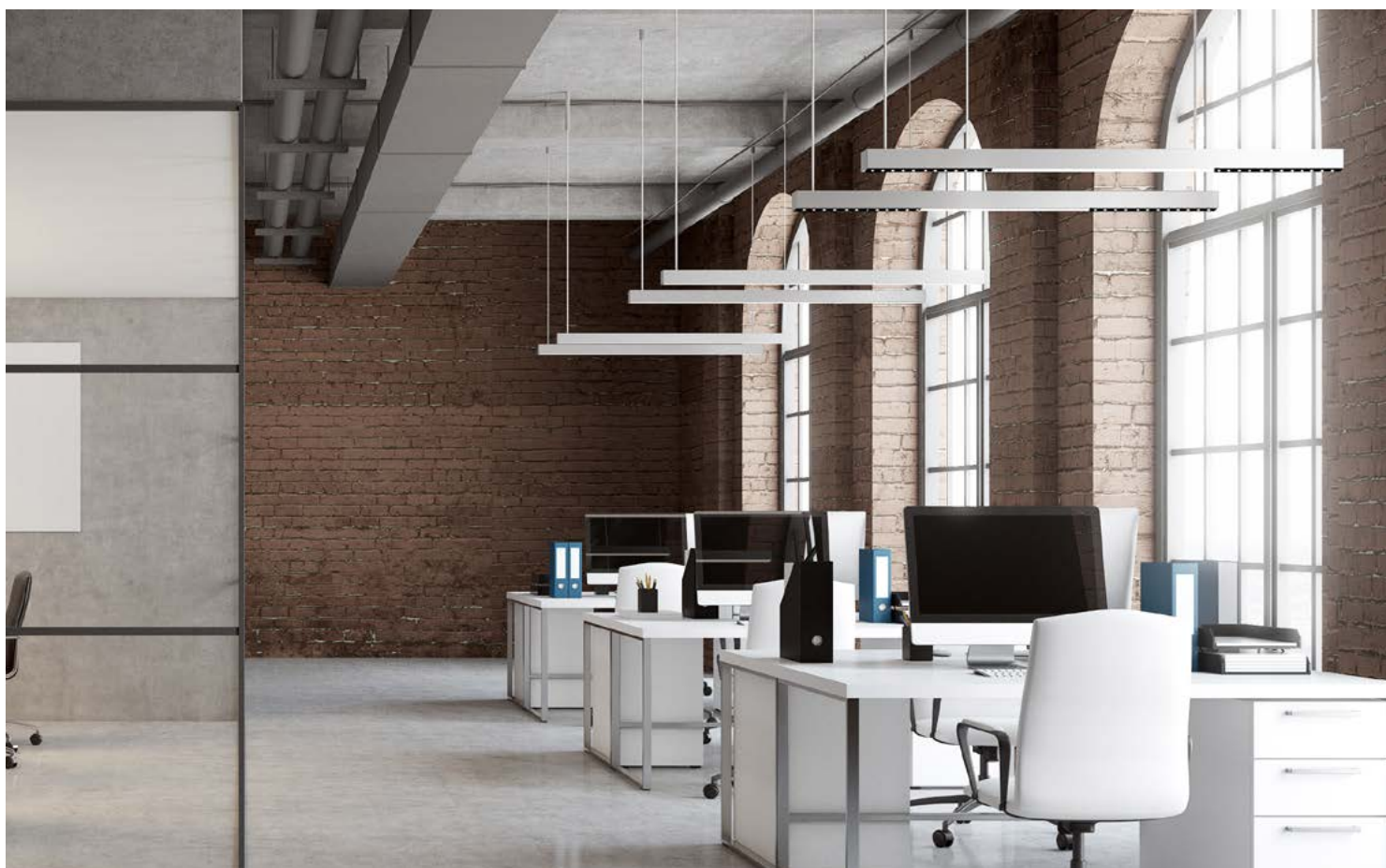

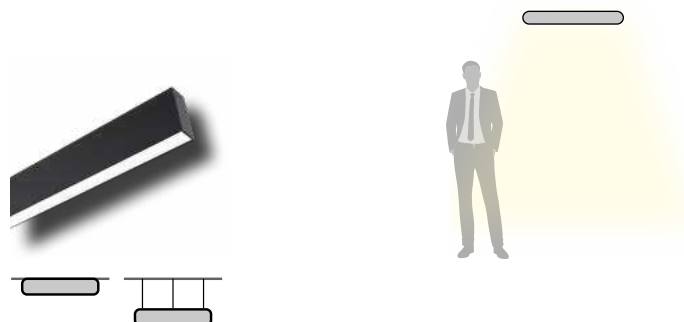

COCKTAIL DIFFUSER

Corpo in estruso di alluminio, testate in acciaio, verniciatura a polveri. Diffusore in policarbonato. Tono luce bianco 4000K o 3000K, Potenze da 28W/1130mm a 56W/2250mm. Alimentatore elettronico e diffusore inclusi. Testate, giunti lineari ed accessori per la sospensione da ordinare a parte.

Structure in powder coated aluminium alloy, steel end caps. Opal polycarbonate diffuser. LED in 4000K or 3000K white tone. Powers from 28W/1130mm up to 56W/2250mm. Electronic driver and diffuser included. End caps, junctions, and kit for recessed installation to be ordered separately.

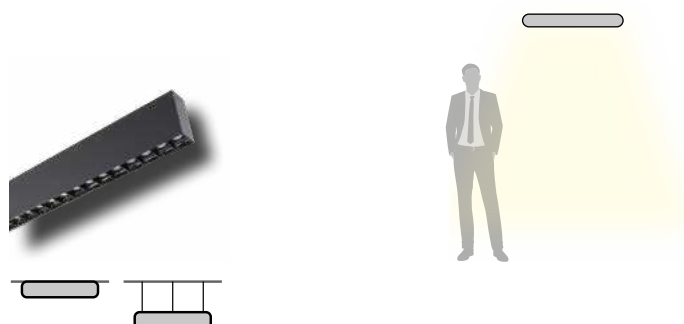

COCKTAIL UGR

Corpo in lega di alluminio, testate in acciaio, verniciatura a polveri. Controllo dell'abbagliamento UGR16 grazie ad un innovativo sistema di ottiche a micro-celle. Tono luce bianco 4000K o 3000K, Potenze da 36W/1190mm a 85W/2245mm. Alimentatore elettronico incluso. Testate, Giunti lineari ed accessori per la sospensione da ordinare a parte.

Structure in powder coated aluminium alloy, steel end caps . Glare control UGR16 thanks to the innovative micro-cells system. LED in 4000K or 3000K white tone. Powers from 36W/1190mm up to 85W/2245mm. Electronic driver included. End caps, junctions, and kit for recessed installation to be ordered separately.

CE	IP20
LED	RG1
CRI 80/90	Driver incl.
L80 B10	Mac Adam 3
	50000H



COCKTAIL

DIFFUSER

Z.
COLOR

bianco/white -02

nero/black -03

custom -99

OPAL
0

X.
CRI80
5

CRI90
6

Y.
5000K
6

4000K
7

3000K
8

DIM.
1-10V
A1

DALI
A2

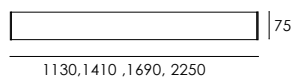
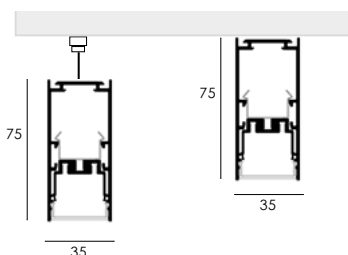

CODICE / CODE	L.MM	W	LM
CTL.3553.0 X Y. Z	1130	28W/230V LED	3920/3820/3620
CTL.3554.0 X Y. Z	1410	35W/230V LED	4910/4780/4540
CTL.3555.0 X Y. Z	1690	42W/230V LED	5880/5730/5430
CTL.3557.0 X Y. Z	2250	56W/230V LED	7840/7640/7240

ACCESSORI / ACCESSORIES



CTL.TE
Testata di chiusura.
End cap.



CTL.CD
Giunto lineare.
Linear joint.



AAA.SO
Sospensioni (coppia).
Suspension kit (pair).



AAA.RA2
Rosone alimentato basic.
Power supply basic.



CTL.DP
Attacco plafone (coppia).
Ceiling bracket (pair).

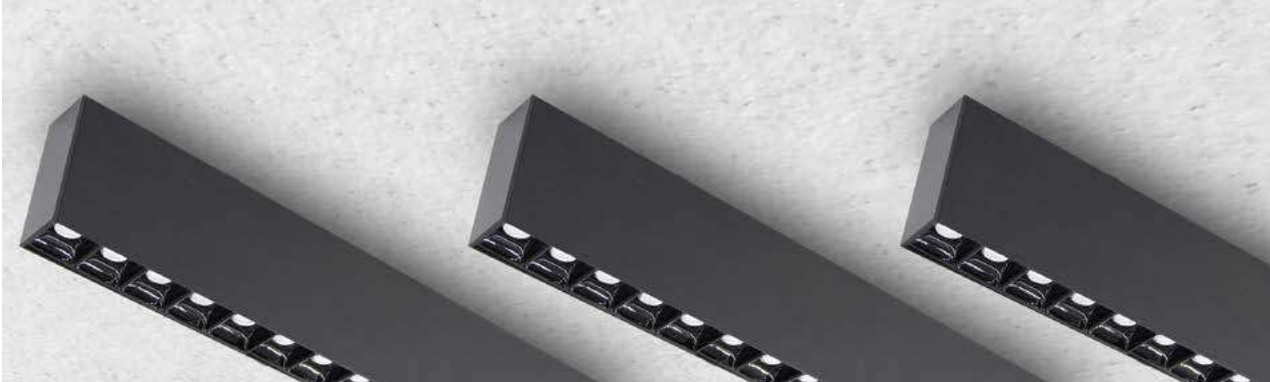

CE	IP20
LED	RG1
CRI 80/90	Driver incl.
L80 B10	Mac Adam 3
⏚	50000H

- 02- bianco/white
- 03- nero/black
- 99- custom

Z.
COLOR

COCKTAIL

UGR

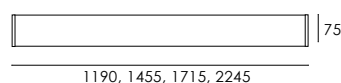
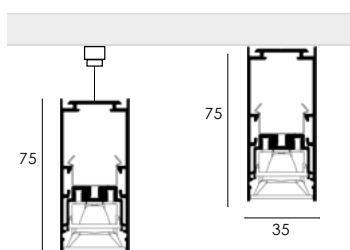

CODICE / CODE

L.MM

W

LM

CTL.3573.1 X Y. Z	1190	36W/230V LED	4564/4144
CTL.3574.1 X Y. Z	1455	45W/230V LED	5407/5179
CTL.3575.1 X Y. Z	1715	55W/230V LED	6489/6215
CTL.3577.1 X Y. Z	2245	85W/230V LED	8652/8287

LENSES
15°
1

X.
CRI80
5

CRI90
6

Y.
5000K
6

4000K
7

3000K
8

DIM.
1-10V
A1

DALI
A2

ACCESSORI / ACCESSORIES



CTL.TE
Testata di chiusura.
End cap.



CTL.CD
Giunto lineare.
Linear joint.



AAA.SO
Sospensioni (coppia).
Suspension kit (pair).



AAA.RA2
Rosone alimentato basic.
Power supply basic.



CTL.DP
Attacco plafone (coppia).
Ceiling bracket (pair).

T-UNI

T-Uni Lens



T-Uni Recessed



T-Uni è una famiglia di sistemi lineari LED installabili singolarmente, in fila continua, a plafone, sospensione ed incasso nel controsoffitto. Elegante nel design, si presta alle applicazioni più diverse, integrandosi perfettamente in contesti residenziali, commerciali, business ed education.

T-Uni is a family of LED linear systems for single or continuous lines, for ceiling, suspended or recessed use. Its elegant design perfectly integrates T-Uni to various applications in residential, commercial and business environments.

T-Uni



T-Uni UGR



T-Uni Recessed
Frameless



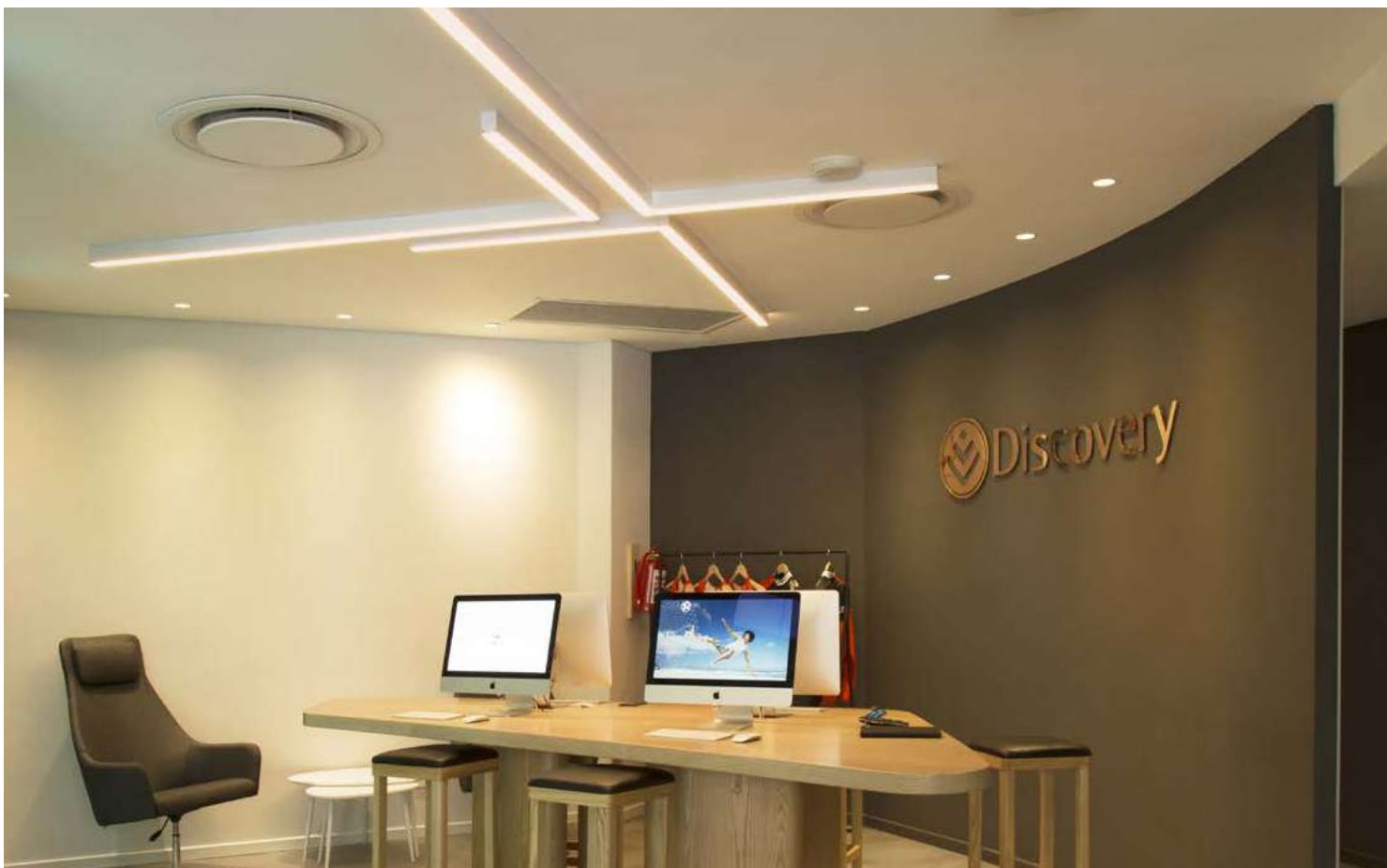

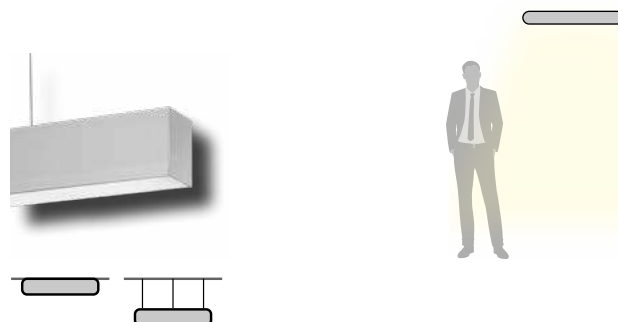

T-UNI

Corpo in lega di alluminio, testate in acciaio, verniciatura a polveri. Diffusore in policarbonato opale o microprismato. Tono luce bianco 5500K, 4000K o 3000K. Potenze da 28W/1130mm a 63W/2530mm.

Alimentatore elettronico e diffusore inclusi. Testate, giunti lineari ed accessori per la sospensione da ordinare separatamente.

Structure in powder coated aluminium alloy, steel end caps. Opal or microprismatic diffuser.

LED in 5500K, 4000K or 3000K white tone.

Powers from 28W/1130mm up to 63W/2530mm.

Electronic driver and diffuser included. End caps, linear joint and kit for suspended installation to be ordered separately.

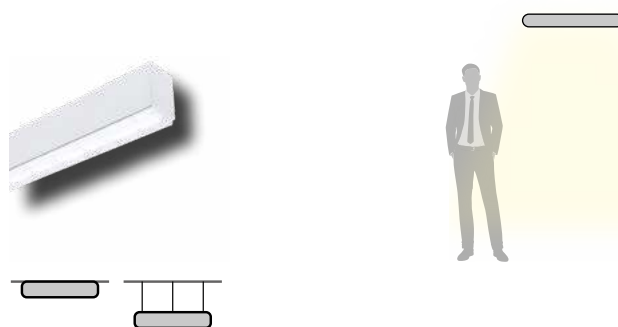

T-UNI LENS

Corpo in lega di alluminio, testate in acciaio, verniciatura a polveri. Ottiche a fascio stretto, largo o retail con micro lenti per il controllo dell'abbagliamento.

Tono di luce bianco 5000K, 4000K o 3000K. Potenze da 32W/1130mm a 71W/2530mm. Alimentatore elettronico incluso. Testate, giunti lineari ed accessori per la sospensione da ordinare a parte.

Structure powder coated aluminium alloy, steel end caps. Narrow, wide, asymmetric and retail beam optics, with micro lenses and glare control. LED in 5500K, 4000K or 3000K white tone.

Powers from 32W/1130mm up to 71W/2530mm. Electronic driver and diffuser included.

Electronic driver and diffuser included. End caps, linear joint and kit for suspended installation to be ordered separately.

CE	IP43
LED	RG1
CRI 80/90	Driver incl.
L80 B10	Mac Adam 3
	50000H



T - U N I

Z. COLOR

bianco/white -02

nero/black -03

custom -99

D. OPAL 0

MICRO PRISMATIC 9

X. CRI80 5

CRI90 6

Y. 5000K 6

4000K 7

3000K 8

DIM. 1-10V A1

DALI A2

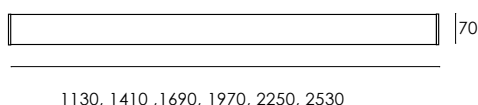
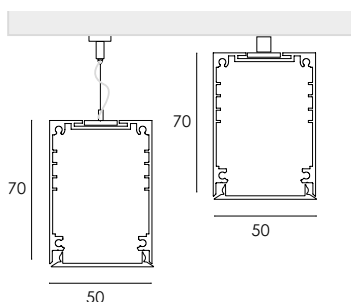

CODICE / CODE	L.MM	W	LM
TNI. 3403.D X Y. Z	1130	28W/230V LED	3920/3820/3620
TNI. 3404.D X Y. Z	1410	35W/230V LED	4910/4780/4540
TNI. 3405.D X Y. Z	1690	42W/230V LED	5880/5730/5430
TNI. 3406.D X Y. Z	1970	49W/230V LED	6870/6690/6350
TNI. 3407.D X Y. Z	2250	56W/230V LED	7840/7640/7240
TNI. 3408.D X Y. Z	2530	63W/230V LED	8830/8600/8160

ACCESSORI / ACCESSORIES



TNI.TE
Testata di chiusura.
End cap.



TNI.CD
Giunto lineare.
Linear joint.



TNI.SO
Sospensioni (coppia).
Suspension kit (pair).



AAA.RA2
Rosone alimentato basic.
Power supply basic.



TNI.DP
Attacco plafone (coppia).
Ceiling bracket (pair).

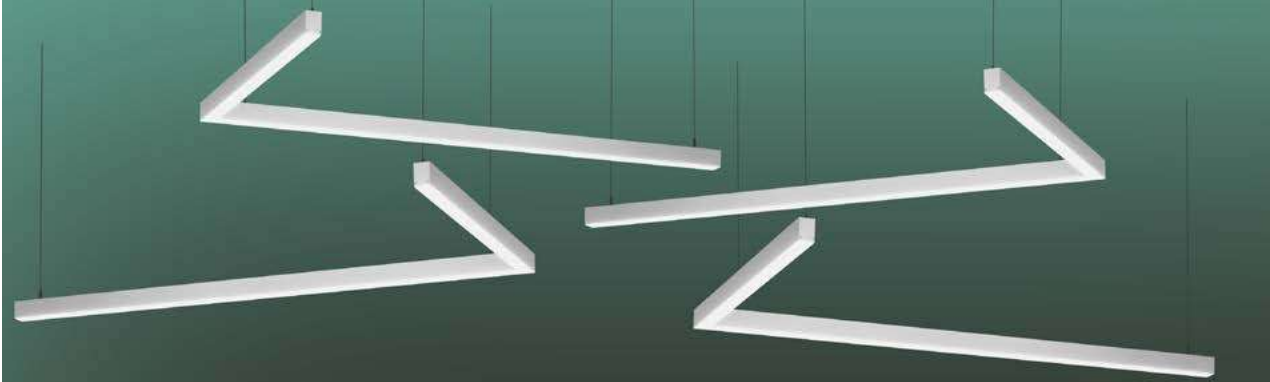

CE	IP43
LED	RG1
CRI 80/90	Driver incl.
L80 B10	Mac Adam 3
⏏	50000H

T - UNI

LENSES

- 02- bianco/white
- 03- nero/black
- 99- custom

Z. COLOR

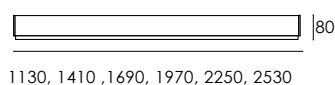
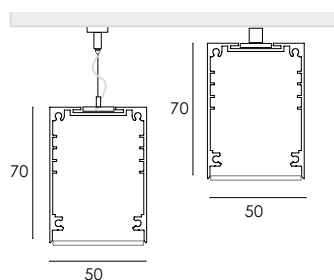

CODICE / CODE	L.MM	W	LM
TNL.3463.D X Y. Z	1130	32W/230V LED	5020/4600/4400
TNL.3464.D X Y. Z	1410	40W/230V LED	6275/5750/5500
TNL.3465.D X Y. Z	1690	48W/230V LED	7530/6900/6600
TNL.3466.D X Y. Z	1970	55W/230V LED	8785/8050/7200
TNL.3467.D X Y. Z	2250	63W/230V LED	10040/9200/8800
TNL.3468.D X Y. Z	2530	71W/230V LED	11295/10350/9900

D. LENSES 30° 1

LENSES 110° 2

LENSES SYM° 3

LENSES ASYM° 4

X. CRI80 5

CRI90 6

Y. 5000K 6

4000K 7

3000K 8

DIM. 1-10V A1

DALI A2

ACCESSORI / ACCESSORIES



TNI.TE
Testata di chiusura.
End cap.



TNI.CD
Giunto lineare.
Linear joint.



TNI.SO
Sospensioni (coppia).
Suspension kit (pair).



AAA.RA2
Rosone alimentato basic.
Power supply basic.



TNI.DP
Attacco plafone (coppia).
Ceiling bracket (pair).



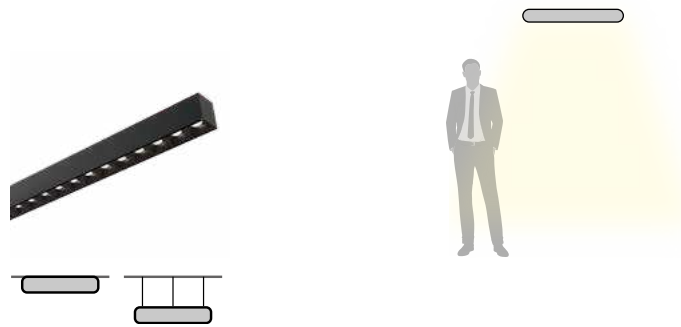

T-UNI UGR

Corpo in lega di alluminio, testate in acciaio, verniciatura a polveri. Controllo dell'abbagliamento UGR < 19 grazie ad un innovativo sistema di ottiche a micro-celle. Tono luce bianco 4000K o 3000K. Potenze da 36W/1130mm a 95W/2530mm. Alimentatore elettronico incluso. Testate, giunti lineari ed accessori per la sospensione da ordinare a parte.

Structure in powder coated aluminium alloy, steel end caps. Glare control UGR < 19 thanks to the innovative micro-cells systems. LED in 4000K or 3000K white tone. Powers from 36W/1130mm up to 95W/2530mm. Electronic driver included. End caps, linear joint, and kit for suspended installation to be ordered separately.

Controllo dell'abbagliamento UGR < 19
Glare control UGR < 19

CE	IP43
LED	RG1
CRI 90	Driver incl.
L80 B10	Mac Adam 3
	50000H



T - U N I

U G R

Z.
COLOR

bianco/white -02

nero/black -03

custom -99

D.
LENSES
60° 1

LENSES
90° 2

LENSES
ASYM° 3

CRI90
6

Y.
4000K
7

3000K
8

DIM.
1-10V
A1

DALI
A2

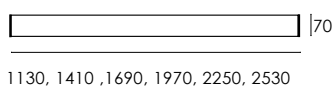
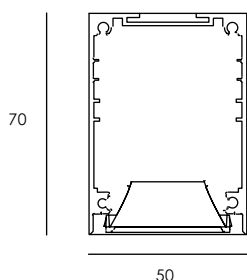

CODICE / CODE	L.MM	W	LM
TNR.3473.D 6 Y. Z	1130	36W/230V LED	4564/4144
TNR.3474.D 6 Y. Z	1410	45W/230V LED	5407/5179
TNR.3475.D 6 Y. Z	1690	55W/230V LED	6489/6215
TNR.3476.D 6 Y. Z	1970	65W/230V LED	7571/7251
TNR.3477.D 6 Y. Z	2250	85W/230V LED	8652/8287
TNR.3478.D 6 Y. Z	2530	95W/230V LED	9971/9323

ACCESSORI / ACCESSORIES

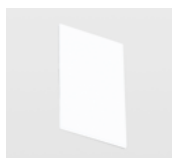

TNI.TE
Testata di chiusura.
End cap.



TNI.CD
Giunto lineare.
Linear joint.



TNI.SO
Sospensioni (coppia).
Suspension kit (pair).



AAA.RA2
Rosone alimentato basic.
Power supply basic.



TNI.DP
Attacco plafone (coppia).
Ceiling bracket (pair).

ASYM



60°







T-UNI RECESSED

Corpo in lega di alluminio, testate in acciaio, verniciatura a polveri. Diffusore in policarbonato opale o microprismato UGR per il controllo dell'abbagliamento. Tono luce bianco 5500K, 4000K o 3000K. Potenze da 28W/1130mm a 63W/2530mm.

Alimentatore elettronico e diffusore inclusi. Testate, giunti lineari ed accessori per l'incasso da ordinare separatamente.

Structure in powder coated aluminium alloy, steel end caps. Opal or microprismatic diffuser for UGR glare control. LED in 5500K, 4000K or 3000K white tone.

Powers from 28W/1130mm up to 63W/2530mm.

Electronic driver and diffuser included. End caps, linear joint and kit for recessed installation to be ordered separately.



T-UNI RECESSED FRAMELESS

Corpo in lega di alluminio, testate in acciaio, verniciatura a polveri. Diffusore in policarbonato opale o microprismato UGR per il controllo dell'abbagliamento. Tono luce bianco 5500K, 4000K o 3000K. Potenze da 28W/1130mm a 63W/2530mm.

Alimentatore elettronico e diffusore inclusi. Testate, giunti lineari ed accessori per l'incasso da ordinare separatamente.

Structure in powder coated aluminium alloy, steel end caps. Opal or microprismatic diffuser for UGR glare control. LED in 5500K, 4000K or 3000K white tone.

Powers from 28W/1130mm up to 63W/2530mm.

Electronic driver and diffuser included. End caps, linear joint and kit for recessed installation to be ordered separately.

CE	IP40
LED	RG1
CRI 80/90	Driver incl.
L80 B10	Mac Adam 3
	50000H

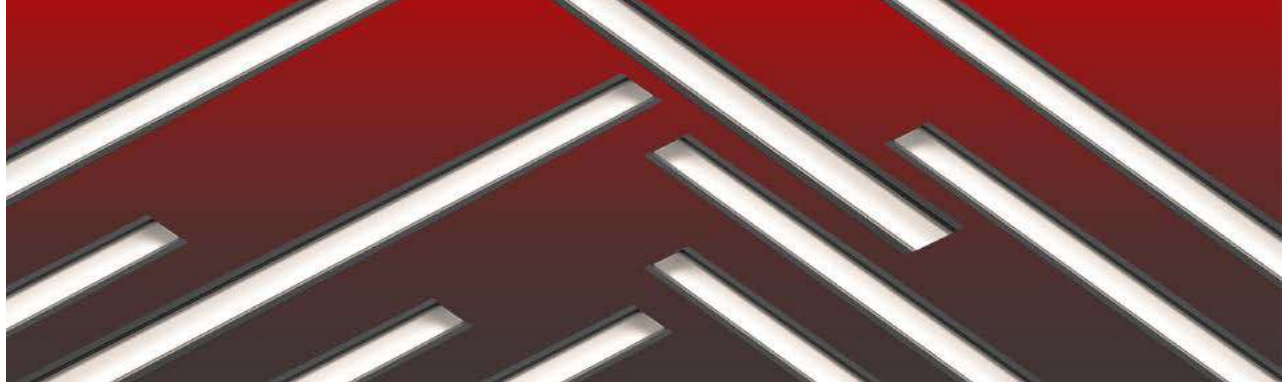

T - U N I

R E C E S S E D

Z.
COLOR

bianco/white -02

nero/black -03

custom -99

D.
OPAL
0

MICRO
PRISMATIC
9

X.
CRI80
5

CRI90
6

Y.
5000K
6

4000K
7

3000K
8

DIM.
1-10V
A1

DALI
A2

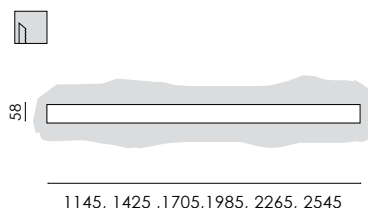
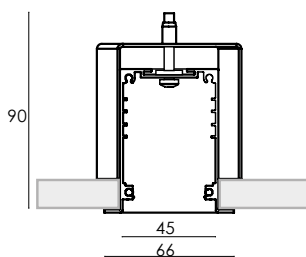

CODICE / CODE	L.MM	W	LM
TNC.3443.D X Y. Z	1130	28W/230V LED	3920/3820/3620
TNC.3444.D X Y. Z	1410	35W/230V LED	4910/4780/4540
TNC.3445.D X Y. Z	1690	42W/230V LED	5880/5730/5430
TNC.3446.D X Y. Z	1970	49W/230V LED	6870/6690/6350
TNC.3447.D X Y. Z	2250	56W/230V LED	7840/7640/7240
TNC.3448.D X Y. Z	2530	63W/230V LED	8830/8600/8160

ACCESSORI / ACCESSORIES



TNC.TE
Testata di chiusura.
End cap.



TNC.MF
Staffa di fissaggio.
Fixing bracket.



TNC.CD
Giunto lineare.
Linear joint.



TNC.CA
Cavo anticaduta.
Suspension cable.



CE	IP40
LED	RG1
CRI 80/90	Driver incl.
L80 B10	Mac Adam 3
	50000H

- 02- bianco/white
- 03- nero/black
- 99- custom

Z.
COLOR

T - UNI

RECESSED FRAMELESS

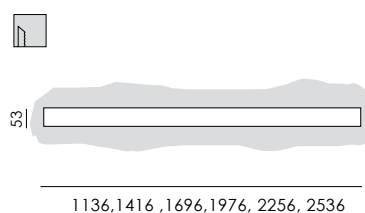
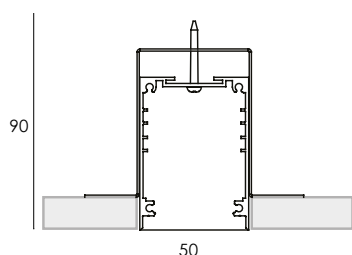

CODICE / CODE	L.MM	W	LM
TNE.3423.D X Y. Z	1130	28W/230V LED	3920/3820/3620
TNE.3424.D X Y. Z	1410	35W/230V LED	4910/4780/4540
TNE.3425.D X Y. Z	1690	42W/230V LED	5880/5730/5430
TNE.3426.D X Y. Z	1970	49W/230V LED	6870/6690/6350
TNE.3427.D X Y. Z	2250	56W/230V LED	7840/7640/7240
TNE.3428.D X Y. Z	2530	63W/230V LED	8830/8600/8160

D.
OPAL
0

MICRO
PRISMATIC
9

X.
CRI80
5

CRI90
6

Y.
5000K
6

4000K
7

3000K
8

DIM.
1-10V
A1

DALI
A2

ACCESSORI / ACCESSORIES



TNE.TE
Testata di chiusura.
End cap.



TNE.MF
Staffa di fissaggio.
Fixing bracket.



TNC.CD
Giunto lineare.
Linear joint.



TNC.CA
Cavo anticaduta.
Suspension cable.

T-3

Serie di profili da sospensione, plafone e da incasso con la versione senza cornice, dalle dimensioni ridotte senza che si pregiudichi la funzionalità. Ideale negli spazi conviviali per incorniciare tavoli da pranzo o valorizzare living room ed open spaces.

Series of suspended, ceiling and recessed profiles with the frameless version, with reduced dimensions without compromising functionality. Ideal in convivial spaces to frame dining tables or enhance living rooms and open spaces.

T-3
Recessed
Frameless

Three recessed T-3 frameless light fixtures are shown in a dark environment. The fixtures are long, narrow, and rectangular, with a slightly angled top surface. They are arranged in a diagonal line from the top right towards the center. The light they emit is a warm, yellowish-white glow, creating a soft shadow on the surface below them.

T-3
Suspended

Four suspended T-3 light fixtures are shown in a dark environment. The fixtures are long, narrow, and rectangular, with a slightly angled top surface. They are arranged in a diagonal line from the top left towards the bottom center. The light they emit is a warm, yellowish-white glow, creating a soft shadow on the surface below them.



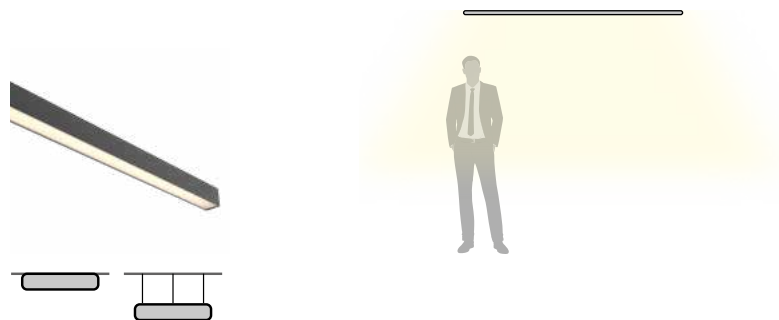

T-3

Sistema modulare in alluminio estruso da plafone o sospensione. Disponibile in due versioni con diffusore opale o microprismato. Accessori da ordinare separatamente.

Modular system in extruded aluminium for ceiling or suspended installation. Available in two versions with opal or microprismatic diffuser. Accessories to be ordered separately.

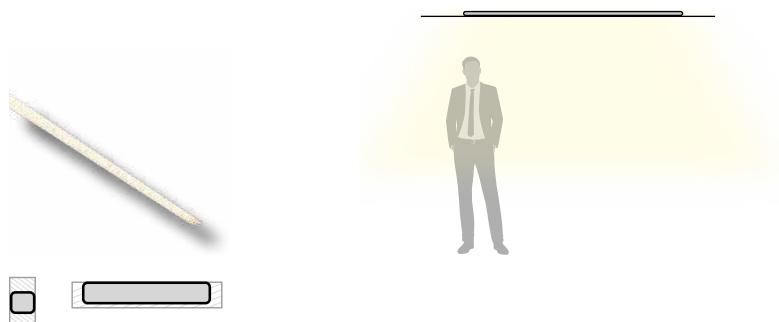

T-3 RECESSED FRAMELESS

Sistema modulare in alluminio estruso da incasso a scomparsa totale. Adatto per cartongesso spessore 9-13mm. Driver on/off e diffusore opale o microprismato inclusi. Testate ed accessori da ordinare a parte.

Modular system in extruded aluminium for trimless recessed installation. Suitable for plasterboards of thickness 9-13mm. Driver and opal or microprismatic diffuser are included. End caps and accessories to be ordered separately.

CE	IP20
LED	RG1
CRI 90	Driver incl.
L80 B10	Mac Adam 3
	50000H

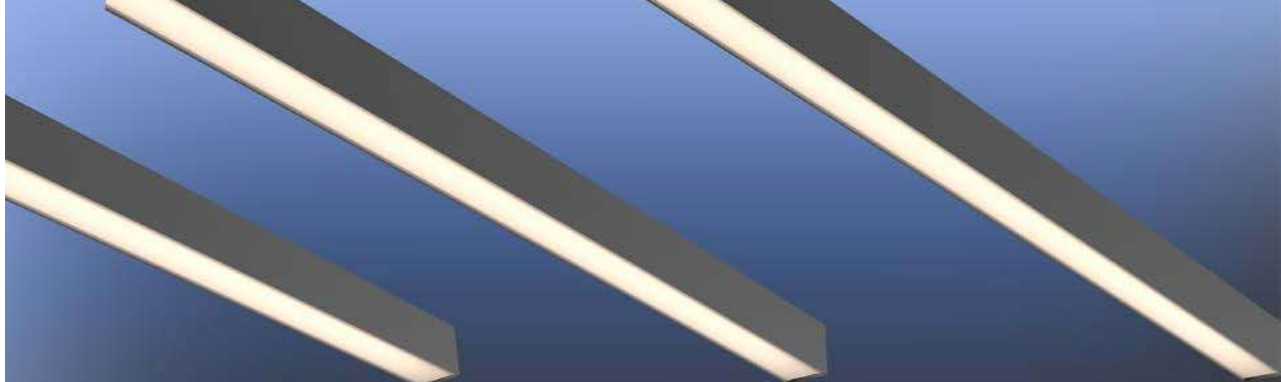

T - 3

Z.
COLOR

bianco/white -02
nero/black -03

D.
OPAL
0

MICRO
PRISMATIC
9

4000K
7

3000K
8

DIM.
1-10V
A1

DALI
A2



CODICE / CODE	L.MM	W	K	LM
T3I.3703.D 6 7. Z	1600	40W/230V LED	4000K	3070
T3I.3703.D 6 8. Z	1600	40W/230V LED	3000K	2780
T3I.3705.D 6 7. Z	2400	60W/230V LED	4000K	4600
T3I.3705.D 6 8. Z	2400	60W/230V LED	3000K	4170

ACCESSORI / ACCESSORIES



T3X.TEA
Testata di chiusura.
End cap.



T3X.SO
Kit di sospensione (coppia).
Suspension kit (pair).



T3X.CDA
Giunto lineare.
Linear joint.



AAA.RA2
Rosone alimentato basic.
Power supply basic.



CE	IP20
LED	RG1
CRI 90	Driver incl.
L80 B10	Mac Adam 3
	50000H

02- bianco/white

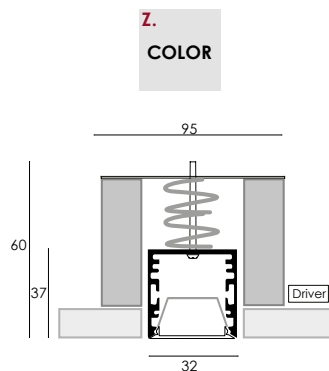

T - 3

RECESSED FRAMELESS

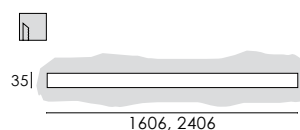

CODICE / CODE	L.MM	W	K	LM
T3E.3723.D 6 7. Z	1600	40W/230V LED	4000	3070
T3E.3723.D 6 8. Z	1600	40W/230V LED	3000	2780
T3E.3725.D 6 7. Z	2400	60W/230V LED	4000	4600
T3E.3725.D 6 8. Z	2400	60W/230V LED	3000	4170

D.
OPAL
0

MICRO PRISMATIC
9

Y.
4000K
7

3000K
8

DIM.
1-10V
A1

DALI
A2

ACCESSORI / ACCESSORIES



T3X.TEA
Testata di chiusura.
End cap.

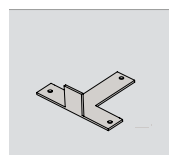

T3X.CLT
Giunto a 3 vie.
3 way joint.

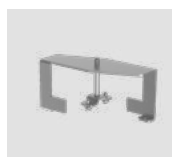

T3X.MFB
Staffa di fissaggio.
Fixing bracket.

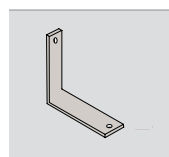

T3X.CLV
Giunto verticale.
Vertical joint.



T3X.CDA
Giunto lineare.
Linear joint.

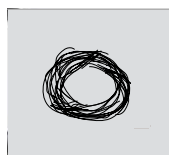

T3X.CA
Cavo anticaduta.
Suspension cable.

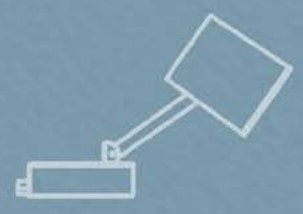
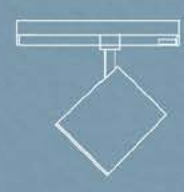
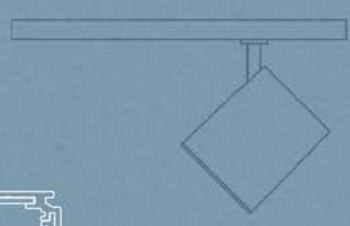
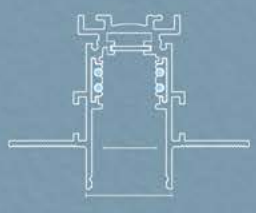
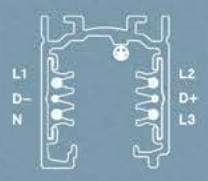
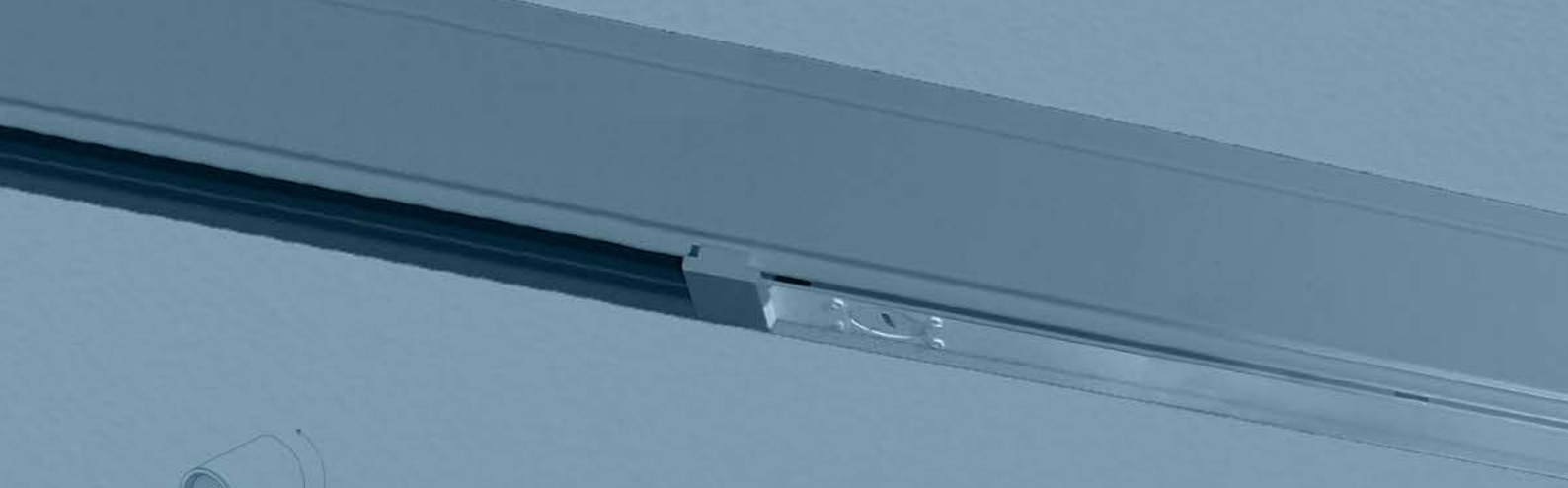

FARETTI Spotlights

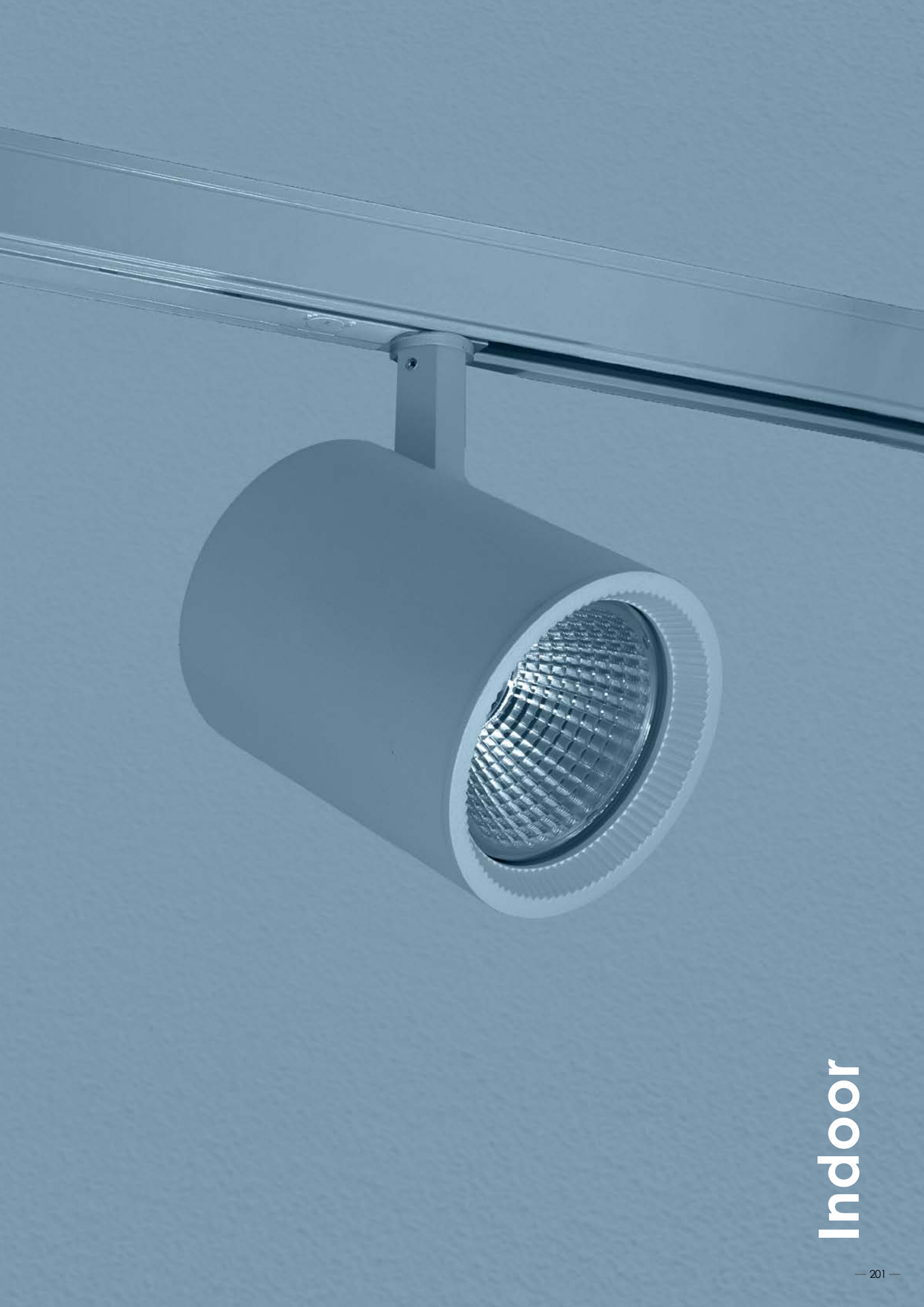

Indoor

DIVA

Plus

Diva è una serie di proiettori a LED per binario Unitrack e per installazione a parete. Design essenziale e proporzioni eleganti sono la caratteristica principale della sua estetica studiata per ottimizzare la gestione passiva del calore. Utilizza ottiche speculari e lenti di ultima generazione. Costruita interamente in Italia, la serie Diva è apprezzata in tutto il mondo per l'eccellente rapporto qualità/prezzo.

DIVA is a series of led projectors for Unitrack and for wall use. Essential design and elegant proportions are the main features of its aesthetics designed to optimize passive heat management. Diva can be equipped with various reflectors or lenses. Entirely are made in Italy our Divas are highly appreciated all over the world for their excellent price/quality ratio.

Abbinalo al **binario 230V**
Match with **230V track**

pag. 210



In



Base

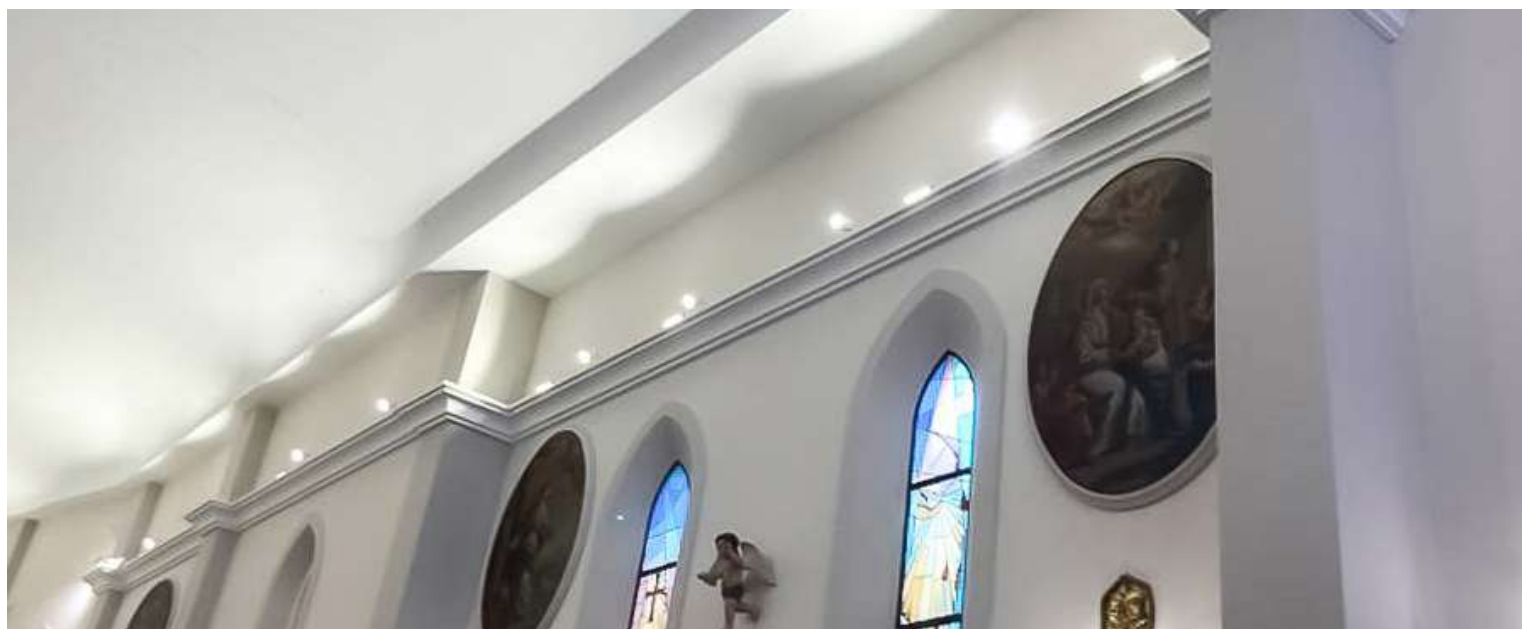
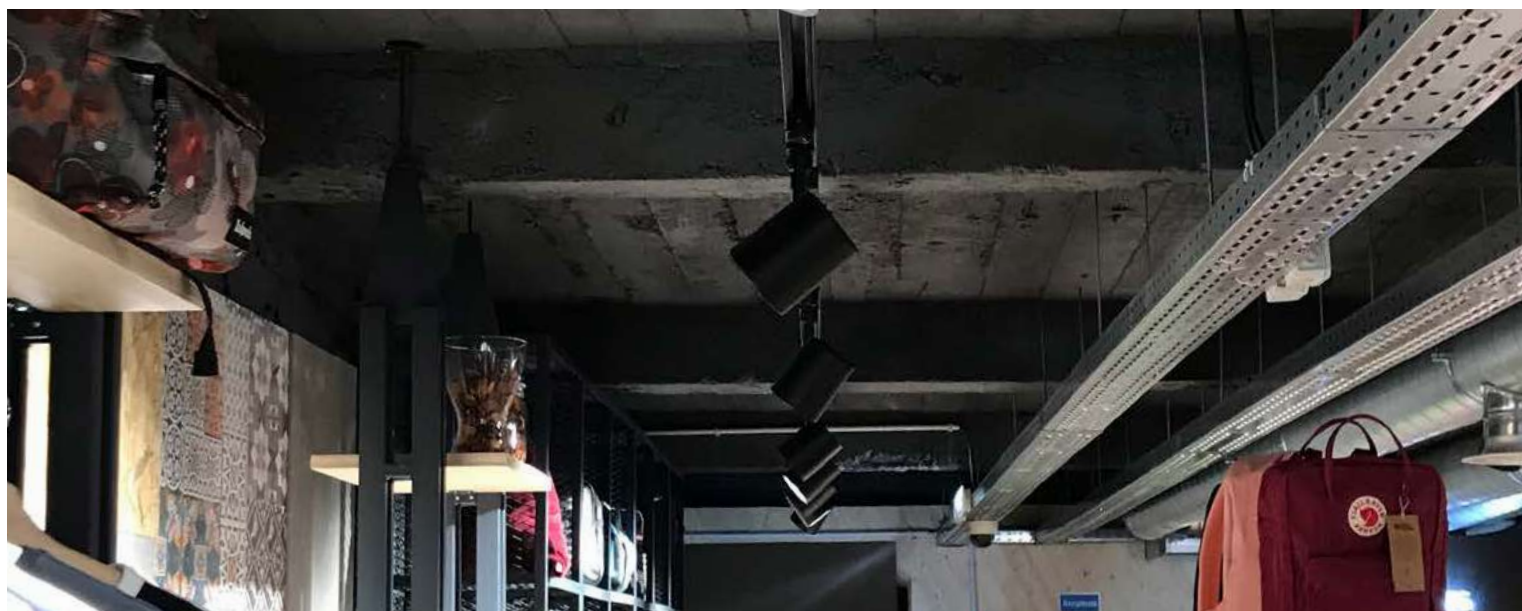



DIVA IN

Corpo ottico, anello e braccio pressofusi in lega di alluminio con verniciatura a polveri. Sorgente luminosa a LED chip on board, CRI 90 o superiore, tono luce bianco 4000K o 3000K, Potenze da 25W a 32W. Alimentatore elettronico incluso nell'adattatore da binario trifase.

Body, ring and arm in powder coated die-cast aluminum alloy. LED light source chip on board CRI 90 or superior, 4000K or 3000K White tone. Power from 25W up to 32W. Driver included in the three phase track adapter.



DIVA PLUS

Corpo ottico, anello e braccio pressofusi in lega di alluminio con verniciatura a polveri. Sorgente luminosa a LED chip on board, CRI 90 o superiore, tono luce bianco 4000K o 3000K. Potenze da 20W a 28W. Alimentatore incluso nell'adattatore a scomparsa nel binario a trifase.

Body, ring and arm in powder coated die-cast aluminum alloy. LED light source chip on board CRI 90 or superior, 4000K or 3000K White tone. Power from 20W to 28W. Hidden three phase track adapter driver included.



DIVA BASE

Corpo ottico e anello pressofusi in lega di alluminio. Braccio in estruso di alluminio con verniciatura a polveri. Sorgente luminosa a LED chip on board CRI 90 o superiore tono luce bianco 4000K o 3000K, Potenze da 32W a 38W. Permette una rotazione di +/- 170° sul piano orizzontale e una inclinazione di +/- 85° sul piano verticale. Alimentatore elettronico incluso nella base.

Body and ring in die-cast aluminum alloy. Arm in powder coated extruded aluminum. LED light source chip on board CRI 90 or superior, 4000K or 3000K White tone. Power from 32W to 38W. It allows +/- 170° horizontal and +/- 85° vertical adjustment. Driver included in the base.

CE	IP20
LED	RG1
CRI 90	Driver incl.
L80 B10	90° 360°
50000H	Mac Adam 3
⏏	



DIVA IN

Z. COLOR

bianco ragg. / rough white - 32	<input type="checkbox"/>
nero ragg. / rough black - 33	<input type="checkbox"/>
grigio chiaro / clear grey - 37	<input type="checkbox"/>
custom -99	<input type="checkbox"/>

D. OPTIC 12.5° 1

OPTIC 37° 2

OPTIC 58° 3

CRI90 6

ART FASHION 3 4

FOOD GOLD 7
MEAT 8
FISH 9

Y. 4000K 7

3000K 8

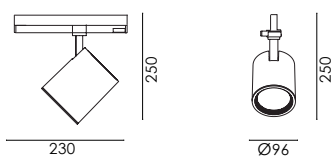

CODICE / CODE	W	LM	FASCIO / BEAM	DRIVER
25 W				
MSA.4464. D 6 Y. Z	25W/230V LED	3450/3290	12.5°/37°/58°	ON/OFF
MSA.4424. D 6 Y. Z	25W/230V LED	3450/3290	12.5°/37°/58°	DALI
MSA.4454. D 6 Y. Z	25W/230V LED	3450/3290	12.5°/37°/58°	CASAMBI ▲
32W				
MSA.4465. D 6 Y. Z	32W/230V LED	4400/4200	12.5°/37°/58°	ON/OFF
MSA.4425. D 6 Y. Z	32W/230V LED	4400/4200	12.5°/37°/58°	DALI
MSA.4455. D 6 Y. Z	32W/230V LED	4400/4200	12.5°/37°/58°	CASAMBI ▲

ACCESSORI / ACCESSORIES



MDI.FC
Copertura riflettore satinata.
Flood satined Lens.



MDI.EL
Diffusore ellittico.
Elliptical lens.



MDI.HC
Diffusore a nido d'ape.
Honeycomb lens.



CE	IP20
LED	RG1
CRI 90	Driver incl.
L80 B10	90° 360°
50000H	Mac Adam 3
⏚	

- 32 - bianco ragg. / rough white
- 33 - nero ragg. / rough black
- 37 - grigio chiaro / clear grey
- 99 - custom

Z.
COLOR

DIVA PLUS

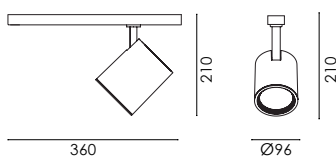

CODICE / CODE	W	LM	FASCIO / BEAM	DRIVER
20 W				
MSA.4474. D 6 Y. Z	20W/230V LED	3170/3000	12.5°/37°/58°	ON/OFF
MSA.4484. D 6 Y. Z	20W/230V LED	3170/3000	12.5°/37°/58°	DALI
28W				
MSA.4475. D 6 Y. Z	28W/230V LED	4320/4140	12.5°/37°/58°	ON/OFF
MSA.4485. D 6 Y. Z	28W/230V LED	4320/4140	12.5°/37°/58°	DALI

D.
OPTIC
12.5°
1

OPTIC
37°
2

OPTIC
58°
3

CRI90
6

ART
FASHION
3
4

FOOD
GOLD 7
MEAT 8
FISH 9

Y.
4000K
7

3000K
8

ACCESSORI / ACCESSORIES



MDI.FC
Copertura riflettore satinata.
Flood satined Lens.



MDI.EL
Diffusore ellittico.
Elliptical lens.



MDI.HC
Diffusore a nido d'ape.
Honeycomb lens.

CE	IP20
LED	RG1
CRI 90	Driver incl.
L80 B10	90° 360°
50000H	Mac Adam 3
⏏	



DIVA BASE

Z. COLOR

- bianco ragg. / rough white - 32
- nero ragg. / rough black - 33
- grigio chiaro / clear grey - 37
- custom -99

D. OPTIC 12.5° 1

OPTIC 37° 2

OPTIC 58° 3

CRI90 6

ART FASHION 3 4

FOOD GOLD 7
MEAT 8
FISH 9

Y. 4000K 7

3000K 8

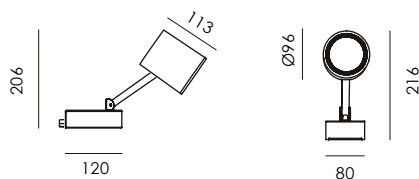

CODICE / CODE	W	LM	FASCIO / BEAM	DRIVER	PREZZO / PRICE
32 W					
MDI.4835. D 6 Y. Z	32W/230V LED	4400/4200	12.5°/37°/58°	ON/OFF	
MDI.4825. D 6 Y. Z	32W/230V LED	4400/4200	12.5°/37°/58°	DALI	
MDI.4855. D 6 Y. Z	32W/230V LED	4400/4200	12.5°/37°/58°	CASAMBI	▲
38 W					
MDI.4836. D 6 Y. Z	38W/230V LED	5000/4800	12.5°/37°/58°	ON/OFF	
MDI.4826. D 6 Y. Z	38W/230V LED	5000/4800	12.5°/37°/58°	DALI	
MDI.4856. D 6 Y. Z	38W/230V LED	5000/4800	12.5°/37°/58°	CASAMBI	▲

ACCESSORI / ACCESSORIES



MDI.FC
Copertura riflettore satinata.
Flood satinated Lens.



MDI.EL
Diffusore ellittico.
Elliptical lens.



MDI.HC
Diffusore a nido d'ape.
Honeycomb lens.

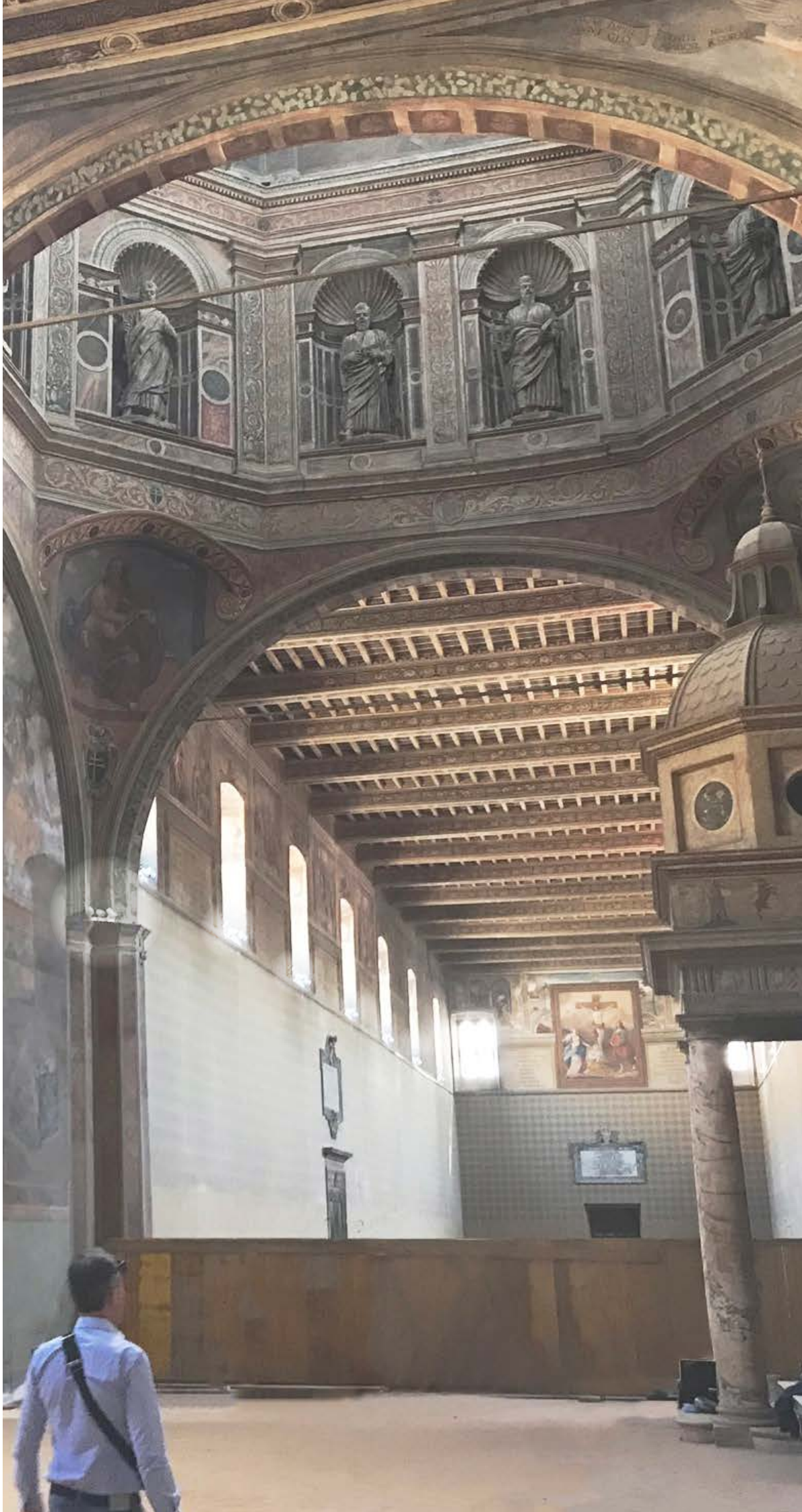



BINARI TRACKS 230V

Serie di binari dimmerabili 230V. Disponibile in diverse lunghezze e 3 varianti di colore.
Dimmable 230V tracks available in 3 different lengths and colors.

Z.
COLOR

- bianco / white - **02**
- nero / black - **03**
- anodizzato / anodised - **05**



CODICE / CODE	L.MM	DRIVER
MBE.4101.001. Z	1000	dimmerabile dali /dali track
MBE.4101.002. Z	2000	dimmerabile dali /dali track
MBE.4101.003. Z	3000	dimmerabile dali /dali track

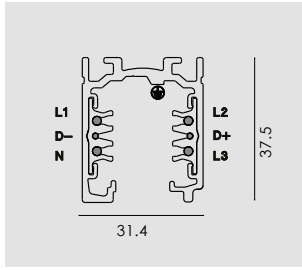

ACCESSORI / ACCESSORIES



MBE.4101.210. Z
Alimentazione (destra).
Live end (right).
MBE.4101.211. Z
Alimentazione (sinistra).
Live end (left).



MBE.4101.610. Z
Giunto a tre vie (interno).
3 way coupling (inside).
MBE.4101.611. Z
Giunto a tre vie (esterno).
3 way coupling (outside).



MBE.4101.310. Z
Alimentazione centrale.
Central feed.



MBE.4101.605
Sospensioni 1,5m (coppia).
Suspension 1,5m (pair).



MBE.4101.410. Z
Giunto lineare.
Linear joint.



MBE.4101.700
Attacco a soffitto.
Ceiling mount.



MBE.4101.510. Z
Giunto a due vie (interno).
2 way coupling (inside).
MBE.4101.511. Z
Giunto a due vie (esterno).
2 way coupling (outside).



MBE.4101.900
Testata di chiusura.
End cap.



DONNA



La famiglia Donna comprende proiettori LED orientabili 48V e apparecchi a binario lineari adattabili al sistema MULTITRACK 48V.

Ottimi per la loro versatilità e alte prestazioni, sono ideali in contesti espositivi, museali così come domestici e per il retail.

The DONNA family includes 48V adjustable LED projectors and linear track luminaires suitable to MULTITRACK 48V system. Excellent for their versatility and high performance, they are ideal in exhibition, museum as well as domestic and retail contexts.

Abbinalo ai **binari 48V**
Match with **48V tracks**

pag. 220



Small
Large
Infinity

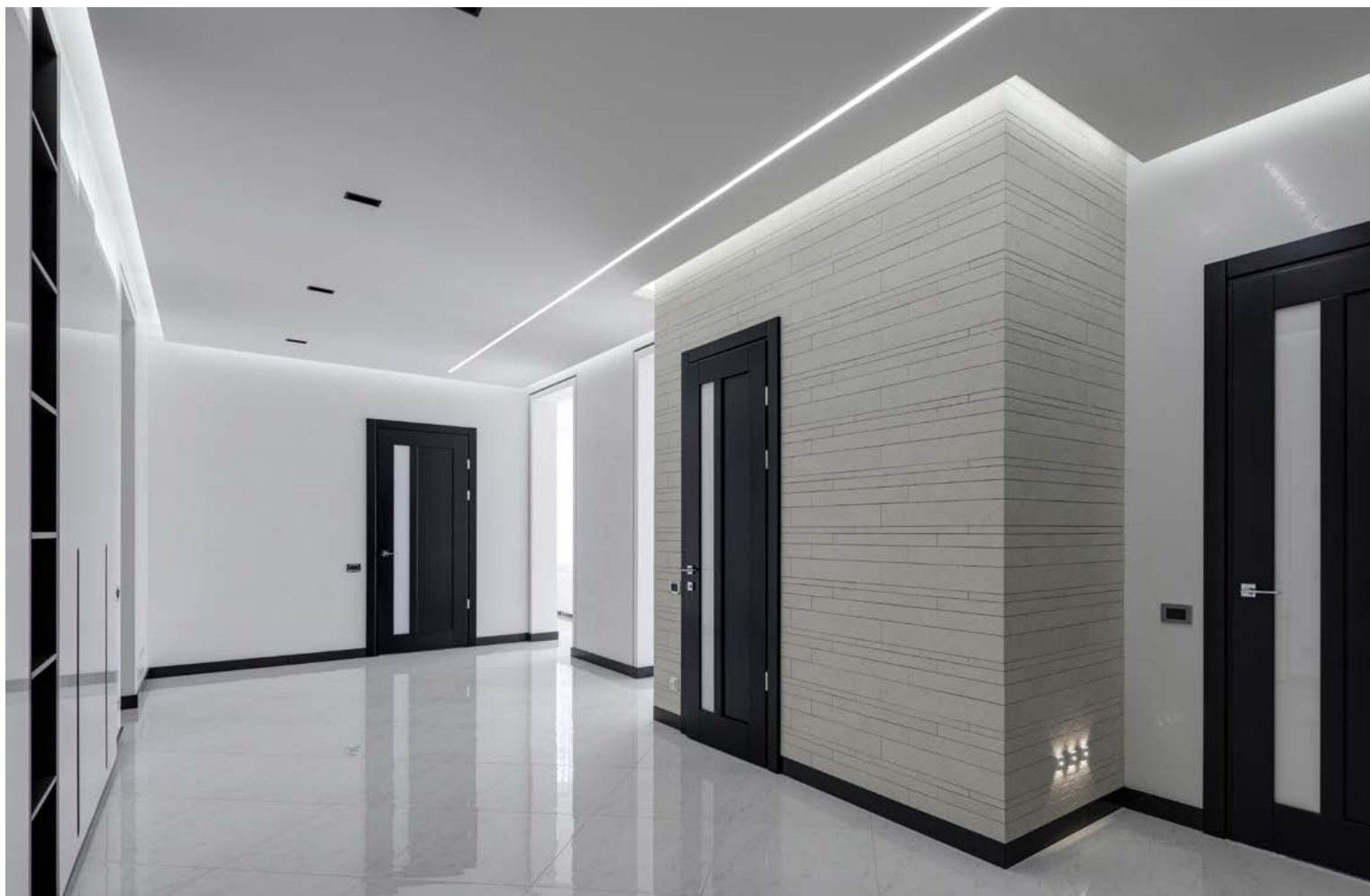



Donna 48V
SMALL



Donna 48V
LARGE



Corpo e anello in lega di alluminio verniciato a polvere. Sorgente luminosa a LED chip on board, CRI 90 o superiore, tono luce bianco 4000K o 3000K, Potenze da 9W a 14W. Alimentatore elettronico incluso nell'adattatore da binario. Disponibile in versione ON-OFF o DALI/PUSH.

Body and ring in powder coated aluminum alloy. LED light source chip on board CRI 90 or superior, 4000K or 3000K White tone. Powers from 9W to 14W. Driver included in the 48V track adapter. Available in ON-OFF or DALI/PUSH version.



Donna 48V
INFINITY

Corpo in lega di alluminio, testate in acciaio, verniciatura a polveri. Diffusore in policarbonato opale o microprismato UGR per il controllo dell'abbagliamento. Tono luce bianco 4000K o 3000K, Potenze da 6W/286mm a 24W/1128mm. Alimentatore elettronico incluso nell'adattatore da binario. Disponibile in versione ON-OFF o DALI/PUSH.

Body in extruded aluminum alloy, end cap in steel, powder coated. Opal or microprismatic diffuser for UGR glare control. LED in 4000K or 3000K white tone, Powers from 6W/286mm up to 24W/1128mm. Driver included in the 48V track adapter. Available in ON-OFF or DALI/PUSH version.

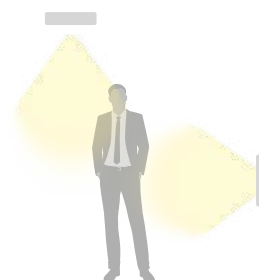

CE	IP20
LED	RG1
CRI 90	48 V
L80 B10	70° 360°
50000H	Corrente Continua
	Direct current

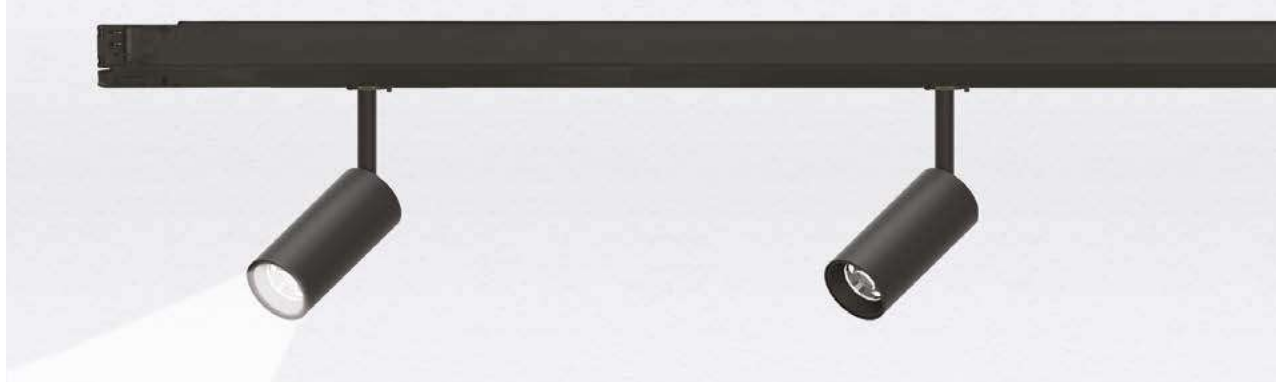

DONNA 48 V SMALL

COLOR

nero ragg. / rough black - 33

D.
OPTIC
20°
1

OPTIC
30°
2

CRI90
6

Y.
4000K
7

3000K
8

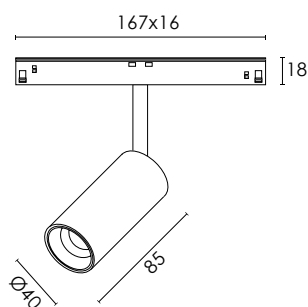

CODICE / CODE	D.MM	W	LM	FASCIO / BEAM	DRIVER
MVI.3703.D 6 Y.33	40	9W/48V	970/950	20°/30°	ON/OFF
MVI.3713.D 6 Y.33	40	9W/48V	970/950	20°/30°	dimmerabile 1-10V



CE	IP20
LED	RG1
CRI 90	48 V
L80 B10	70° 360°
50000H	Corrente Continua
	Direct current

■ 33 - nero ragg. / rough black

COLOR

DONNA 48 V LARGE

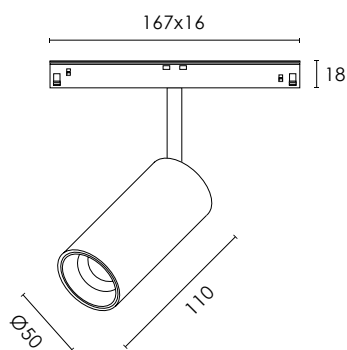

D.
OPTIC
12°
1

OPTIC
24°
2

OPTIC
36°
3

CRI90
6

Y.
4000K
7

3000K
8

CODICE / CODE	D.MM	W	LM	FASCIO / BEAM	DRIVER
MVI.3705.D 6 Y.33	50	14W/48V	1370/1350	12°/24°/36°	ON/OFF
MVI.3715.D 6 Y.33	50	14W/48V	1370/1350	12°/24°/36°	dimmerabile 1-10V
MVI.3725.D 6 Y.33	50	14W/48V	1370/1350	12°/24°/36°	dimmerabile DALI

CE	IP20
LED	RG1
CRI 90	48 V
L80 B10	50000H
	Corrente Continua
	Direct current

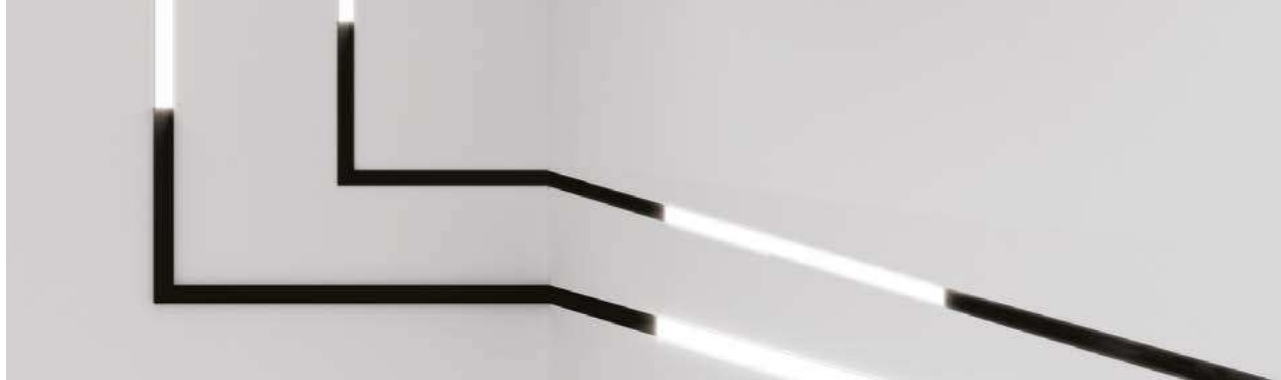

DONNA 48 V

INFINITY

COLOR

nero ragg. / rough black - 33 ■

D.
OPAL
0

MICRO
PRISMATIC
9

CRI90
6

Y.
4000K
7

3000K
8

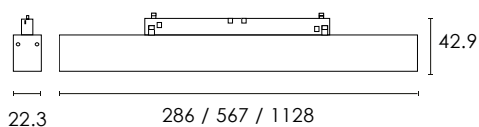

CODICE / CODE	L.MM	W	LM	DRIVER
MVI.6703.D 6 Y. 33	286	6W/48V	810/740	ON/OFF
MVI.6704.D 6 Y. 33	567	12W/48V	1600/1480	ON/OFF
MVI.6724.D 6 Y. 33	567	12W/48V	1600/1480	dimmerabile DALI
MVI.6705.D 6 Y. 33	1128	24W/48V	3200/2970	ON/OFF
MVI.6725.D 6 Y. 33	1128	24W/48V	3200/2970	dimmerabile DALI

ABBINALO A / PAIR IT WITH

BINARIO C
TRACK C

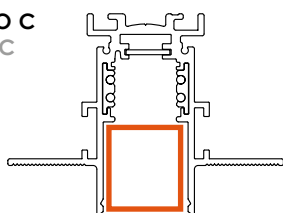

BINARIO D
TRACK D

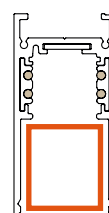

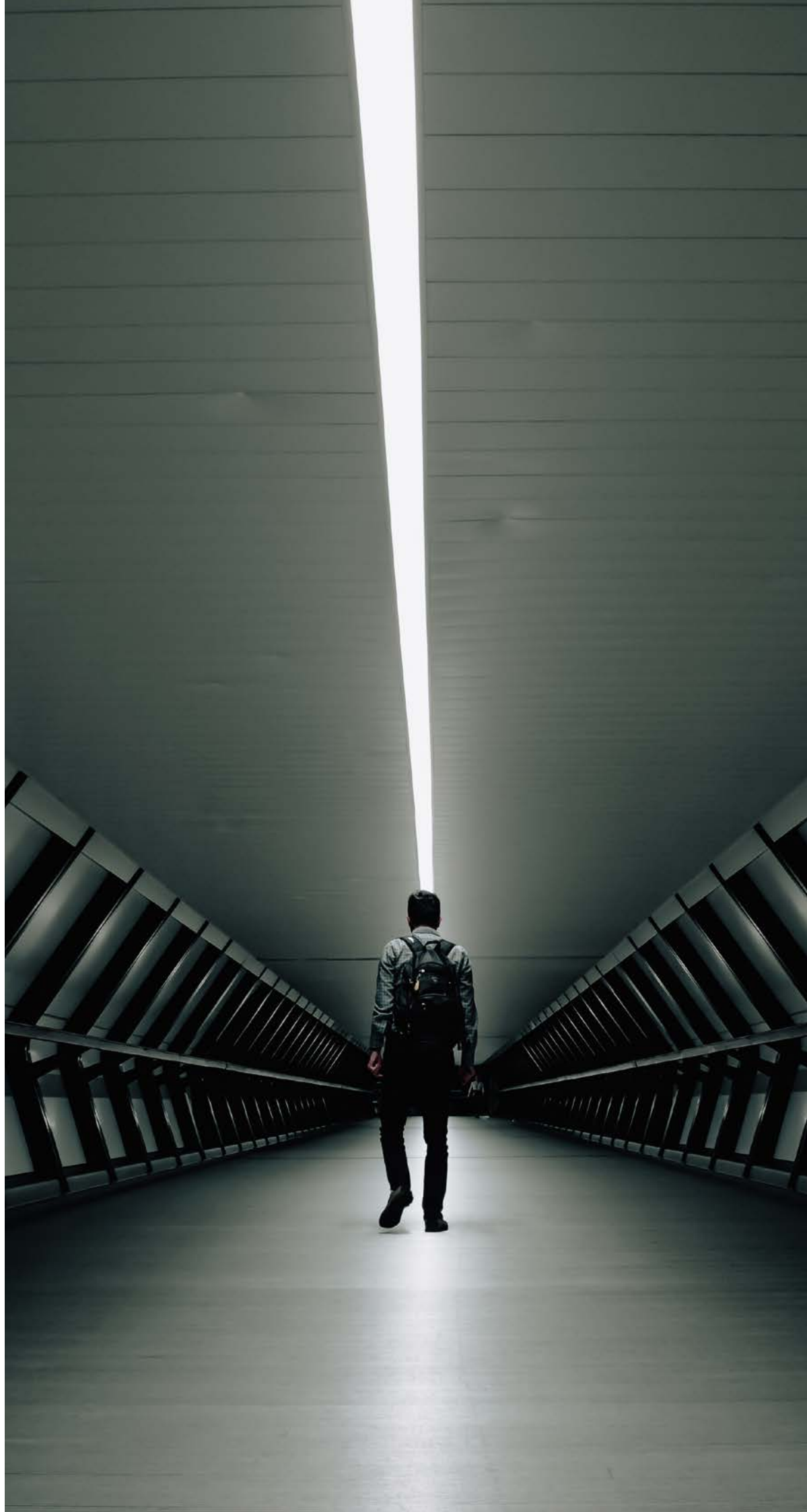

CE	IP20
DALI	Corrente Continua
	Direct current

BINARI TRACKS 48V

Serie di binari MULTI TRACK 48V. Disponibile in diverse lunghezze per rispondere alle diverse richieste di utilizzo.

48V MULTI TRACKS are available in 3 different lengths for different kind of installations.

COLOR

nero ragg. / rough black - 33

Scegli il tuo binario

Choose your track

Donna
small
large



A. Binario standard 48V. Standard track 48V.

CODICE / CODE	L
MBL.4102.011	L.1m
MBL.4102.012	L.2m
MBL.4102.013	L.3m

A

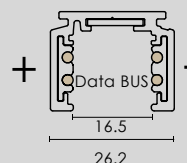

B. Binario basic 48V. Basic track 48V.

CODICE / CODE	L
MBL.4102.061	L.1m
MBL.4102.062	L.2m
MBL.4102.063	L.3m

B

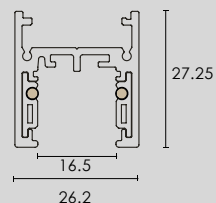

Donna
Infinity



C. Binario H 48V. Track H 48V.

CODICE / CODE	L
MBL.4102.021	L.1m
MBL.4102.022	L.2m
MBL.4102.023	L.3m

C

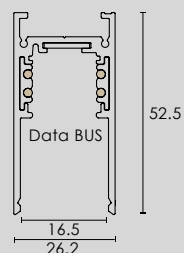

D. Binario da incasso trimless 48V. Trimless recessed track 48V.

CODICE / CODE	L
MBL.4102.051	L.1m
MBL.4102.052	L.2m
MBL.4102.053	L.3m

D

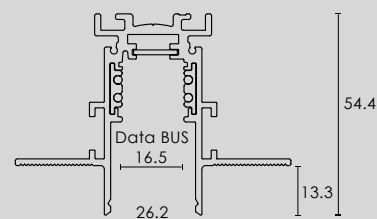

COMPLETA IL TUO MODULO

COMPLETE YOUR MODULE

Tappo di chiusura

End cap

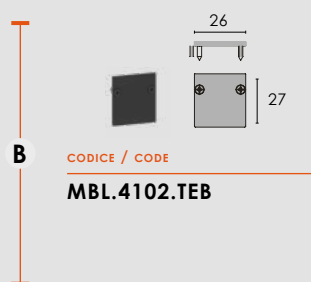
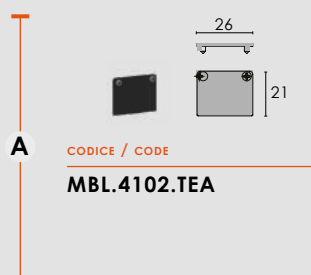

Kit di sospensione

Suspension kit (pair)

COPPIA - PAIR

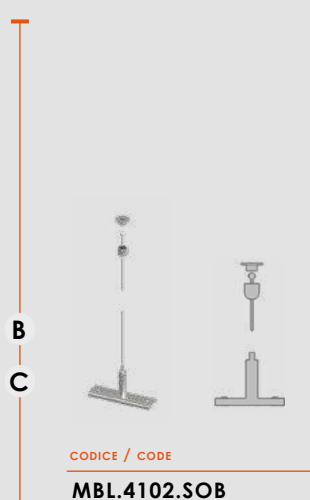

Alimentazione 48 V

Live end 48V



Kit Alimentazione per binari 48V

Power supply kit for 48V tracks

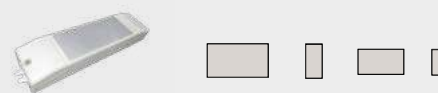

CODICE / CODE	W
MBL.RA-1	70W ON/OFF
MBL.RA-2	150W ON/OFF
MBL.RA-2-A2	150W DALI

Giunto passante 48V

Linear joint 48V

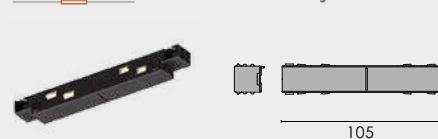

Giunto a L 48V

L feed 48V

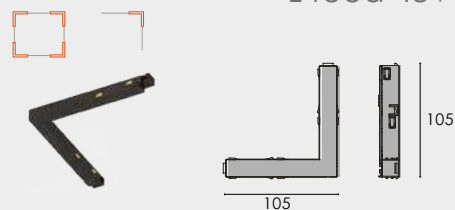

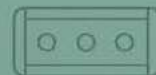
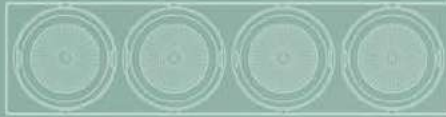

DOWNLIGHTS

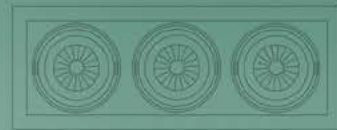
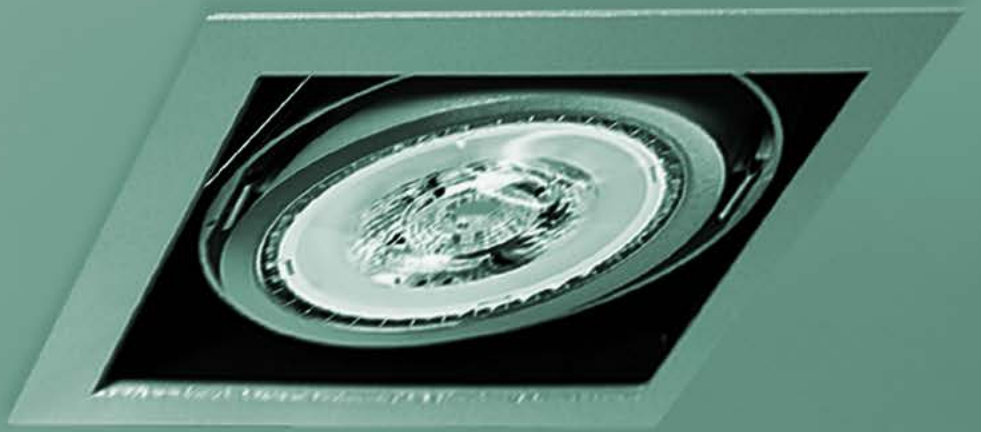
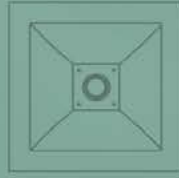

Indoor

FLUX



Flux è una collezione di apparecchi da incasso dalle forme essenziali e razionali. La luce prodotta risulta diffusa e gradevole, e la sua versatilità lo rende adatto ad ambienti dalle diverse dimensioni.

Flux is a collection of recessed lights with essential and rational shapes. The light produced is diffuse and pleasant, and its versatility makes it suitable for environments of different sizes.



FLUX

Cornice in pressofusione di alluminio verniciato a polveri. Struttura in lamiera di acciaio e ottica in alluminio purissimo e ad alto rendimento.

Vetro di protezione temperato, interamente o parzialmente sabbato.

Frame in powder-coated die-cast aluminium. Steel sheet structure and high performance pure aluminium optics.

Tempered protection glass with partial or frosted finish.

CE	IP43
LED	RG1
CRI 80/90	Driver incl.
L80 B10	Mac Adam 3
50000H	



FLUX

Z.
COLOR

- bianco / white - **02**
- nero / black - **03**
- grigio chiaro opaco / clear matt grey - **37**
- custom - **99**

D.
PARZIALMENTE
SABBIATO
PARTIALLY
SANDED **0**

**SABBIATO
SANDED
1**

X.
CRI80
5

**CRI90
6**

**4000K
7**

**3000K
8**

**DIM
1-10V
A1**

**DALI
A2**

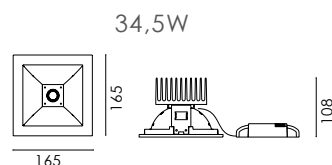
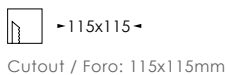
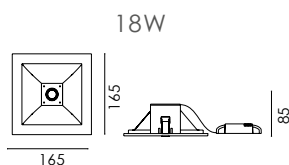

CODICE / CODE	L.MM	W	K	LM
SMALL				
JEE.5309. D X 7. Z	165x165	18W/230V LED	4000K	2700
JEE.5309. D X 8. Z	165x165	18W/230V LED	3000K	2550
JEE.5310. D X 7. Z	165x165	34,5W/230V LED	4000K	4400
JEE.5310. D X 8. Z	165x165	34,5W/230V LED	3000K	4200

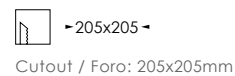
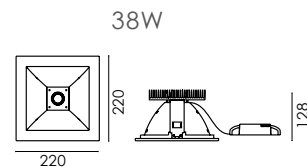
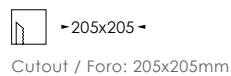
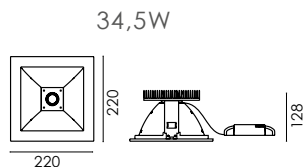
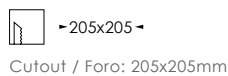
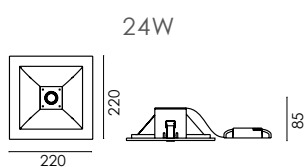

CODICE / CODE	L.MM	W	K	LM
LARGE				
JEE.5311. D X 7. Z	220x220	24W/230V LED	4000K	3600
JEE.5311. D X 8. Z	220x220	24W/230V LED	3000K	3450
JEE.5312. D X 7. Z	220x220	34,5W/230V LED	4000K	5000
JEE.5312. D X 8. Z	220x220	34,5W/230V LED	3000K	4800
JEE.5313. D X 7. Z	220x220	38W/230V LED	4000K	5300
JEE.5313. D X 8. Z	220x220	38W/230V LED	3000K	5050



MODO



Modo è una collezione di apparecchi da incasso che grazie al suo caratteristico gruppo ottico orientabile risulta l'ideale per spazi espositivi e commerciali. La luce potente e concentrata e le numerose varianti rendono Modo LED estremamente versatile, specialmente grazie all'orientabilità di 30° su due assi.

Modo is a collection of recessed lights which is ideal for exhibition and commercial spaces thanks to its characteristic swivelling optical unit. Powerful, concentrated light and numerous variants make Modo LED extremely versatile, especially thanks to the fact that it can be adjusted by 30° in two axes.



MODO

La struttura degli apparecchi è in alluminio pressofuso verniciato. Disponibile anche nella versione senza cornice. Incassi ad 1/2/3/4 lampade, con riflettore per fascio da 24° o 40°. Orientabile di 30° su due assi.

The structure of the lights is made of painted die-cast aluminium. Frame and frameless version. Available with the 1/2/3/4 lamps versions, 24 ° or 40 ° beam angle. Optical group that can be oriented at 30° on two axis.

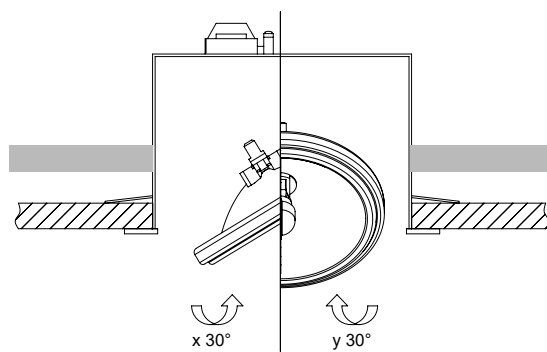

CE	IP20
LED	RG1
CRI 80/90	Driver incl.
L80 B10	Mac Adam 3
50000H	30°
⏚	



M O D O

1 LIGHT

Z. COLOR

- bianco ragg. / rough white - 32
- nero ragg. / rough black - 33
- grigio chiaro / clear grey - 37
- custom -99

D. 24° 1

40° 2

X. CRI80 5

CRI90 6

Y. 4000K 7

3000K 8

DIM 1-10V A1

DALI A2

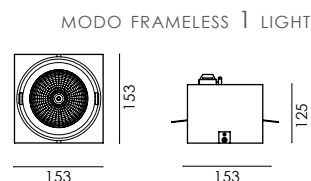
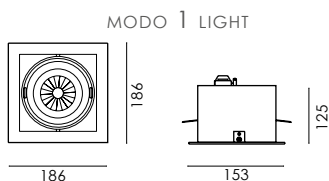

155x155
Cutout / Foro: 155x155mm

155x155
Cutout / Foro: 155x155mm

CODICE / CODE	L.	L.MM	W	LM
MODO 1 LIGHT				
MOD.5211.D X Y. Z	1 light	186x186	16W/230V COB LED	1350/1250
MOD.5221.D X Y. Z	1 light	186x186	23W/230V COB LED	1950/1850
MOD.5231.D X Y. Z	1 light	186x186	33W/230V COB LED	3600/3300
MODO FRAMELESS 1 LIGHT				
MOB.5211.D X Y. Z	1 light	186x186	16W/230V COB LED	1350/1250
MOB.5221.D X Y. Z	1 light	186x186	23W/230V COB LED	1950/1850
MOB.5231.D X Y. Z	1 light	186x186	33W/230V COB LED	3600/3300



CE	IP20
LED	RG1
CRI 80/90	Driver incl.
L80 B10	Mac Adam 3
50000H	30°
⏚	

- 32 - bianco ragg. / rough white
- 33 - nero ragg. / rough black
- 37 - grigio chiaro / clear grey
- 99 - custom

Z.
COLOR

MODO 2 LIGHTS

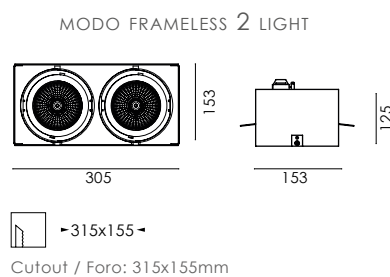
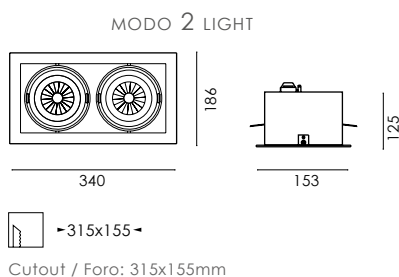

CODICE / CODE	L.	L.MM	W	LM
MODO 2 LIGHTS				
MOD.5212.D X Y. Z	2 light	340x186	2x16W/230V COB LED	2700/2500
MOD.5222.D X Y. Z	2 light	340x186	2x23W/230V COB LED	3900/3700
MOD.5232.D X Y. Z	2 light	340x186	2x33W/230V COB LED	7200/6600
MODO FRAMELESS 2 LIGHTS				
MOB.5212.D X Y. Z	2 light	340x186	2x16W/230V COB LED	2700/2500
MOB.5222.D X Y. Z	2 light	340x186	2x23W/230V COB LED	3900/3700
MOB.5232.D X Y. Z	2 light	340x186	2x33W/230V COB LED	7200/6600

- D.**
24°
1
- 40°
2
- X.**
CRI80
5
- CRI90
6
- Y.**
4000K
7
- 3000K
8
- DIM**
1-10V
A1
- DALI
A2

CE	IP20
LED	RG1
CRI 80/90	Driver incl.
L80 B10	Mac Adam 3
50000H	30°
⊥	



MODO 3 LIGHTS

Z. COLOR

bianco ragg. / rough white - 32	<input type="checkbox"/>
nero ragg. / rough black - 33	<input type="checkbox"/>
grigio chiaro / clear grey - 37	<input type="checkbox"/>
custom -99	<input type="checkbox"/>

D.

24°

1

40°

2

X.

CRI80

5

CRI90

6

Y.

4000K

7

3000K

8

DIM

1-10V

A1

DALI

A2

MODO 3 LIGHTS

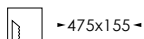
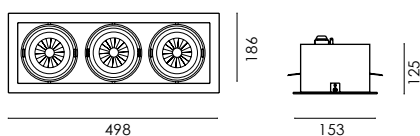

Cutout / Foro: 475x155mm

MODO FRAMELESS 3 LIGHTS

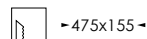
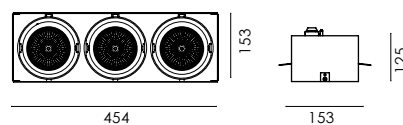

Cutout / Foro: 475x155mm

CODICE / CODE	L.	L.MM	W	LM
MODO 3 LIGHTS				
MOD.5213.D X Y. Z	3 light	498x186	3x16W/230V COB LED	4050/3750
MOD.5223.D X Y. Z	3 light	498x186	3x23W/230V COB LED	5850/5550
MOD.5233.D X Y. Z	3 light	498x186	3x33W/230V COB LED	10800/10200
MODO FRAMELESS 3 LIGHTS				
MOB.5213.D X Y. Z	3 light	498x186	3x16W/230V COB LED	4050/3750
MOB.5223.D X Y. Z	3 light	498x186	3x23W/230V COB LED	5850/5550
MOB.5233.D X Y. Z	3 light	498x186	3x33W/230V COB LED	10800/10200



CE	IP20
LED	RG1
CRI 80/90	Driver incl.
L80 B10	Mac Adam 3
50000H	30°
⏚	

- 32 - bianco ragg. / rough white
 - 33 - nero ragg. / rough black
 - 37 - grigio chiaro / clear grey
 - 99 - custom
- Z. COLOR**

MODO 4 LIGHTS

MODO 4 LIGHT

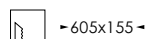
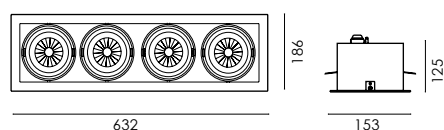

Cutout / Foro: 605x155mm

MODO FRAMELESS 4 LIGHT

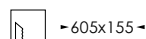
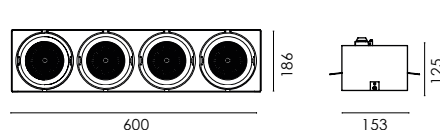

Cutout / Foro: 605x155mm

CODICE / CODE	L.	L.MM	W	LM
MODO 4 LIGHTS				
MOD.5214.D X Y. Z	4 light	632x186	4x16W/230V COB LED	5400/5000
MOD.5224.D X Y. Z	4 light	632x186	4x23W/230V COB LED	7800/7400
MOD.5234.D X Y. Z	4 light	632x186	4x33W/230V COB LED	14400/13600
MODO FRAMELESS 4 LIGHTS				
MOB.5214.D X Y. Z	4 light	632x186	4x16W/230V COB LED	5400/5000
MOB.5224.D X Y. Z	4 light	632x186	4x23W/230V COB LED	7800/7400
MOB.5234.D X Y. Z	4 light	632x186	4x33W/230V COB LED	14400/13600

D.
24°
1

40°
2

X.
CRI80
5

CRI90
6

Y.
4000K
7

3000K
8

DIM
1-10V
A1

DALI
A2





AIR

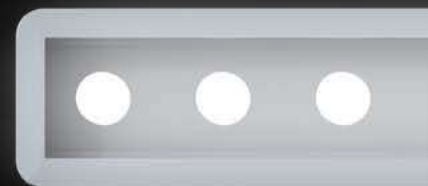
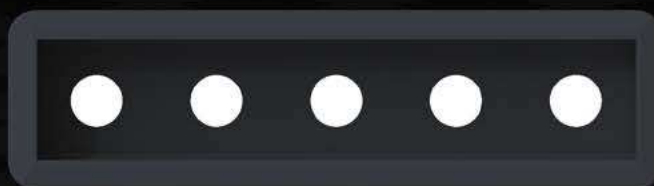
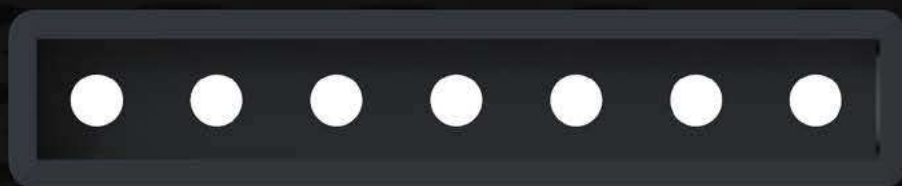
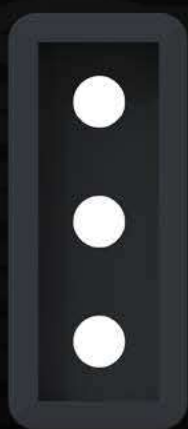

AIR è un sistema a sorgenti multiple perfetto per l'illuminazione di negozi e uffici. Grazie al suo design minimale e alle sue dimensioni ridotte può essere inserito anche in contesti abitativi dallo stile moderno e si adatta a tutti gli ambienti, creando un effetto abbagliamento ridotto.

AIR is a multi-source system that is perfect for shop and office lighting. Thanks to its minimalist design and small dimensions, it can also be used in modern living spaces and fits into any environment, creating a reduced glare effect.

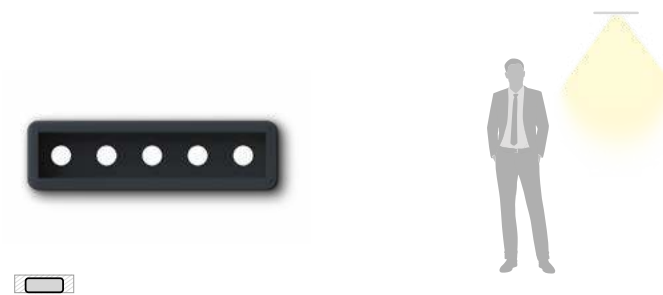

AIR

Serie di apparecchi da incasso per interni. Corpo in alluminio con verniciatura raggrinzante. Disponibile in 4 modelli standard: dal più piccolo a 1 LED fino a una sezione da 7 LED. Lenti a 25° o 60°. Facilmente personalizzabile.

Alimentabile a 350 o 500 mA. Alimentatore escluso.

Series of recessed luminaires for indoor use. Realized in coated aluminium. Available in 4 standard models: from the smallest 1 LED up to a 7 LED section. 25° or 60° lenses. Easily customisable.

Air can be supplied at 350 or 500 mA. Driver excluded.

CE	IP20
LED	RG1
CRI 80/90	50000H
L80 B10	Mac Adam 3

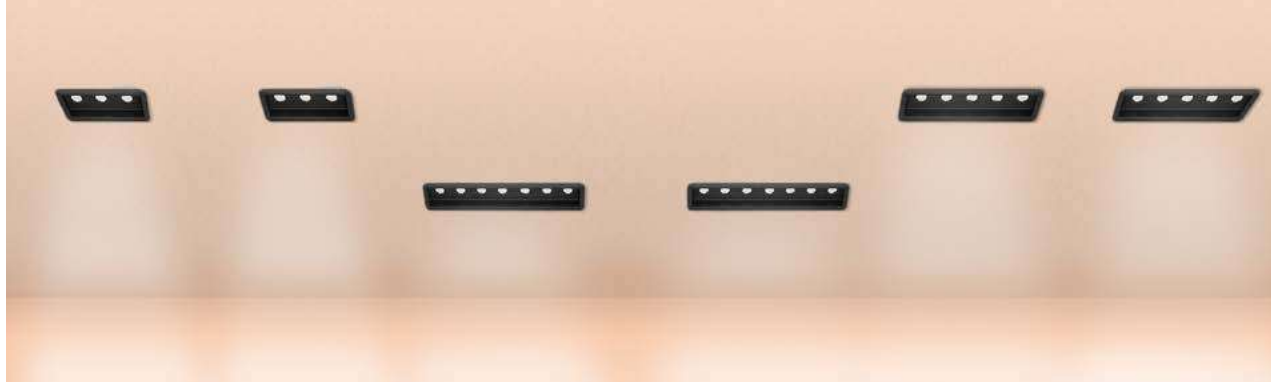

AIR

Z. COLOR

- bianco ragg. / rough white - **32**
- nero ragg. / rough black - **33**
- grigio chiaro / clear grey - **37**
- custom - **99**

- OPTIC 25° **2**
- OPTIC 60° **6**
- X. CRI80 **5**
- CRI90 **6**
- Y. 4000K **7**
- 3000K **8**
- DIM 1-10V **A1**
- DALI **A2**

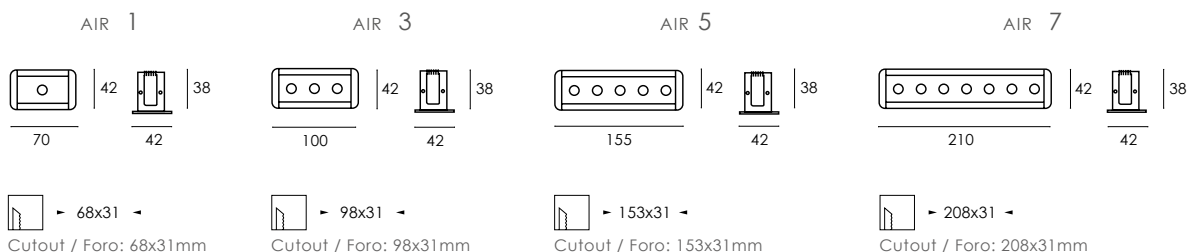

CODICE / CODE	D.MM	W	LM	FASCIO / BEAM
AIR 1				
JAI.5261. 2 X Y. Z	70x42	1.2/2W/230V LED 350/500mA	108/93	25°
JAI.5261. 6 X Y. Z	70x42	1.2/2W/230V LED 350/500mA	108/93	60°
AIR 3				
JAI.5263. 2 X Y. Z	100x42	3x1.2/2W/230V LED 350/500mA	323/278	25°
JAI.5263. 6 X Y. Z	100x42	3x1.2/2W/230V LED 350/500mA	323/278	60°
AIR 5				
JAI.5265. 2 X Y. Z	155x42	5x1.2/2W/230V LED 350/500mA	538/462	25°
JAI.5265. 6 X Y. Z	155x42	5x1.2/2W/230V LED 350/500mA	538/462	60°
AIR 7				
JAI.5267. 2 X Y. Z	210x42	7x1.2/2W/230V LED 350/500mA	756/650	25°
JAI.5267. 6 X Y. Z	210x42	7x1.2/2W/230V LED 350/500mA	756/650	60°

ACCESSORI / ACCESSORIES



AAA.TRSL00
Driver IP20 3W/350mA.



AAA.TRSL41
Driver IP20 6W/500mA.



AAA.TRSL05
Driver IP20 19W/350mA.



AAA.TRSL45
Driver IP20 20W/500mA.



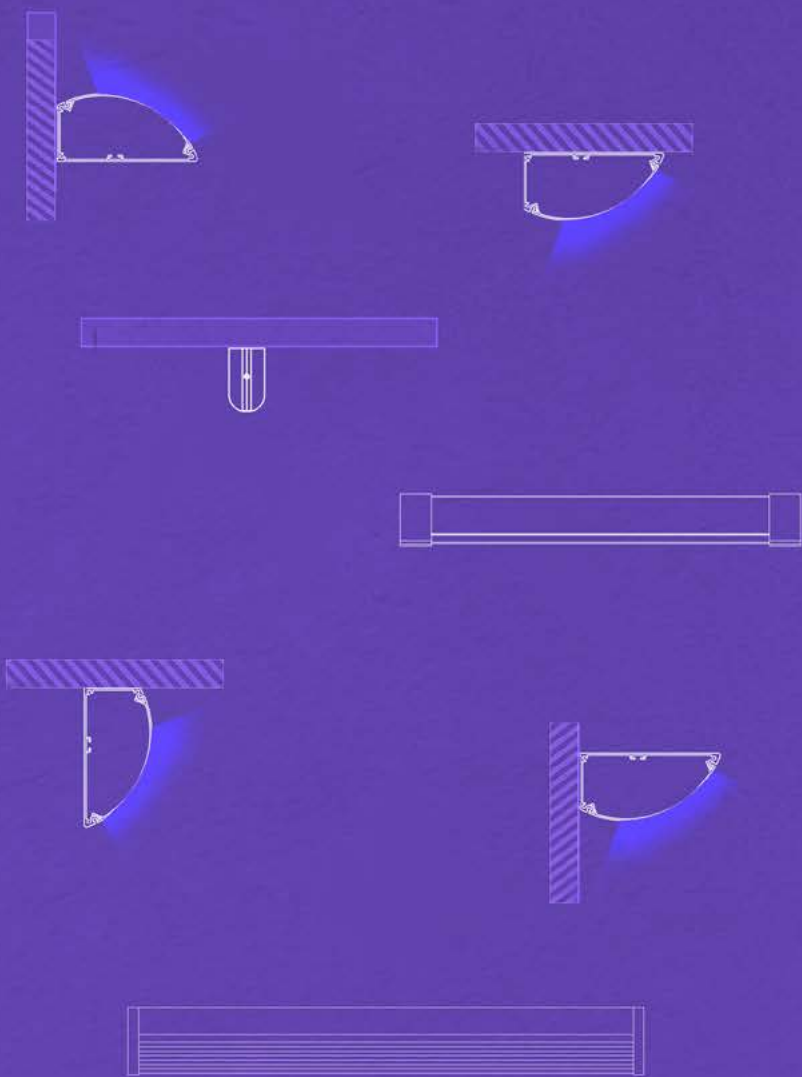

LUCI D'AMBIENTE

Ambient lights

Indoor

F - S E R I E S

F-44

Appliques da parete che hanno da sempre contraddistinto la nostra produzione. Per un'illuminazione pratica e funzionale trovano collocazione soprattutto negli spazi in cui l'alto livello di umidità richiede un grado di protezione maggiorato, ad esempio per illuminazione di cucine e bagni.

Wall fittings that have always distinguished our production. For practical and functional lighting, it is especially suitable for spaces where the high level of humidity requires an increased degree of protection, for example kitchens and bathrooms.



F-55

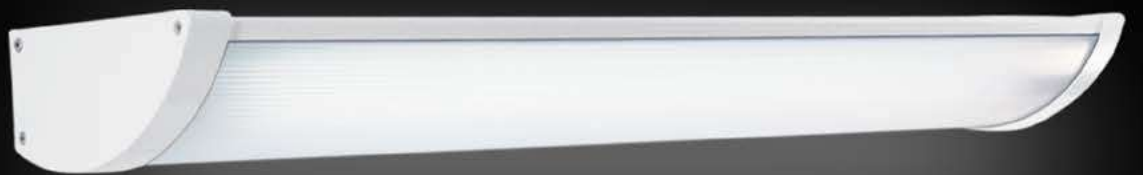



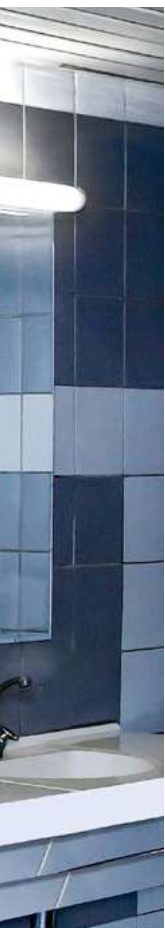

F-44

Corpo in lega di alluminio estruso, testate in tecnopolimero, verniciatura a polveri. Diffusore in policarbonato opale. Tono luce bianco 4000K o 3000K, Potenze da 14W/640mm a 28W/1250mm. Alimentatore elettronico e diffusore inclusi. Disponibile in versione con sensore di presenza

Structure in powder coated aluminium alloy, end caps in techno polymer . Opal polycarbonate diffuser. LED in 4000K or 3000K white tone. Powers from 14W/640mm up to 28W/1250mm. Electronic driver and diffuser included. Motion sensors version available.



F-55

Corpo in lega di alluminio estruso, testate in tecnopolimero, verniciatura a polveri. Diffusore in policarbonato opale. Tono luce bianco 4000K o 3000K, Potenze da 14W/580mm a 28W/1180mm. Alimentatore elettronico e diffusore inclusi.

Structure in powder coated aluminium alloy, end caps in techno polymer . Opal polycarbonate diffuser. LED in 4000K or 3000K white tone. Powers from 14W/580mm up to 28W/1180mm. Electronic driver and diffuser included. Motion sensors version available.

CE	IP44
LED	RG1
CRI 80/90	Driver incl.
L80 B10	Mac Adam 3
	50000H
850°	



F - 4 4

Z. COLOR

bianco/white -02

X. CRI80 5

CRI90 6

4000K 7

3000K 8

DIM. 1-10V A1

DALI A2

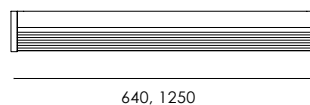
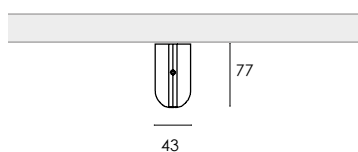

CODICE / CODE	L.MM	W	K	LM
F44.3211.0 X 7. 02	640	14W/230V LED	4000K	1585
F44.3211.0 X 8. 02	640	14W/230V LED	3000K	1502
F44.3213.0 X 7. 02	1250	28W/230V LED	4000K	3170
F44.3213.0 X 8. 02	1250	28W/230V LED	3000K	3004

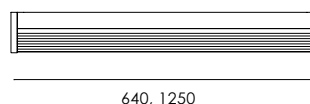
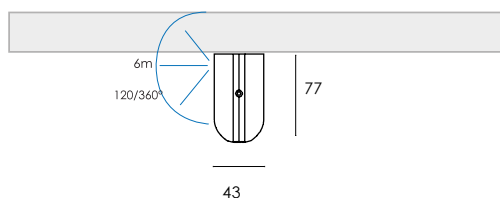

CODICE / CODE	L.MM	W	K	LM
CON SENSORE DI PRESENZA/ WITH PRESENCE SENSOR				
F44.3211MS.0 X 7. Z	640	14W/230V LED	4000K	1585
F44.3211MS.0 X 8. Z	640	14W/230V LED	3000K	1502
F44.3213MS.0 X 7. Z	1250	28W/230V LED	4000K	3170
F44.3213MS.0 X 8. Z	1250	28W/230V LED	3000K	3004



CE	IP44
LED	RG1
CRI 80/90	Driver incl.
L80 B10	Mac Adam 3
	50000H
850°	

02- bianco/white

Z.
COLOR

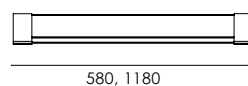
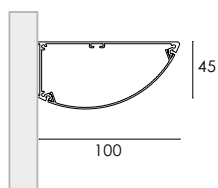

F - 5 5

CODICE / CODE	L.MM	W	K	LM
F55.5015.0 X 7. 02	580	14W/230V LED	4000K	1585
F55.5015.0 X 8. 02		14W/230V LED	3000K	1502
F55.5017.0 X 7. 02	1180	28W/230V LED	4000K	3170
F55.5017.0 X 8. 02	1180	28W/230V LED	3000K	3004

X.
CRI80
5

CRI90
6

4000K
7

3000K
8

DIM.
1-10V
A1

DALI
A2



PROFILI PER
STRIP LED

TAPELIGHT
PROFILES



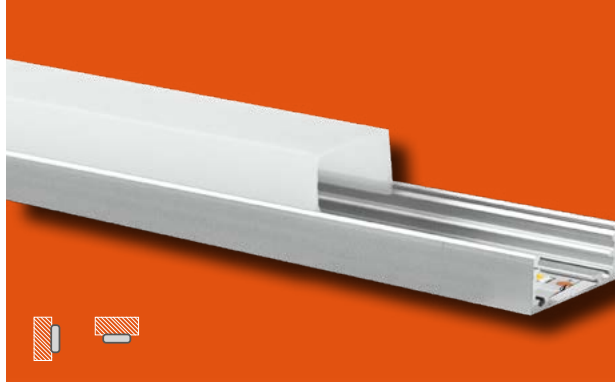

Zero Surface profilo da superficie. Disponibile in barre da 2m e 3m. Adatto solo per Strip LED da 6-10mm.

Zero Surface profile. Available in 2m and 3m lengths. Suitable for 6-10mm tapelight only.



ZERO SURFACE

COLOR

bianco/white -02
anodizzato/anodized -05

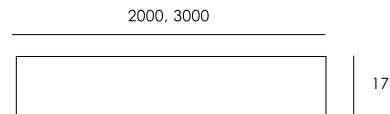
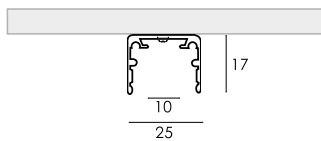

CODICE / CODE	L.MM	COLORE/ COLOR
003.023.2000.05	2000	anodizzato / anodised
003.023.2000.02	2000	bianco / white
003.023.3000.05	3000	anodizzato / anodised
003.023.3000.02	3000	bianco / white

CODICE / CODE	L.MM	DIFFUSORE / DIFFUSER
PIANO/ FLAT		



005.023.2001.22	2000	opalino/ opal
005.023.3001.22	3000	opalino/ opal



TONDO/ ROUND		
005.023.2002.22	2000	opalino / opal
005.023.2002.23	2000	acidato / frosted
005.023.3002.22	3000	opalino / opal
005.023.3002.23	3000	acidato / frosted



QUADRO/ SQUARE		
005.023.2003.22	2000	opalino / opal
005.023.2003.23	2000	acidato / frosted
005.023.3003.22	3000	opalino / opal
005.023.3003.23	3000	acidato / frosted

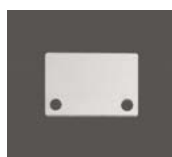

002.023.8020
Testata piano.
Flat end cap.



002.023.8022
Testata quadra.
Square end cap.



002.023.8021
Testata tonda.
Round end cap.



032.023.0001
Staffa di fissaggio.
Fixing bracket

Base-1 profilo da superficie. Disponibile in barre da 2m e 3m. Adatto solo per Strip LED da 6-10mm.
Base-1 surface profile. Available in 2m and 3m lengths. Suitable for 6-10mm tapelight only.



- 02- bianco/white
- 05- anodizzato/ anodized

COLOR

BASE 1

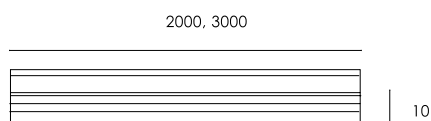
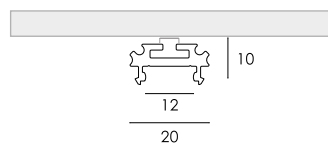

CODICE / CODE	L.MM	COLORE/ COLOR
003.024.2000.05	2000	anodizzato / anodised
003.024.2000.02	2000	bianco / white
003.024.3000.05	3000	anodizzato / anodised
003.024.3000.02	3000	bianco / white

CODICE / CODE	L.MM	DIFFUSORE / DIFFUSER
PIANO/ FLAT		
005.031.2001.22	2000	opalino/ opal
005.031.3001.22	3000	opalino/ opal



CODICE / CODE	L.MM	DIFFUSORE / DIFFUSER
FASCIO STRETTO/ NARROW BEAM		
005.024.2003.23	2000	trasparente / clear
005.024.3003.23	3000	trasparente / clear



002.024.8013
Testata piano.
Flat end cap.

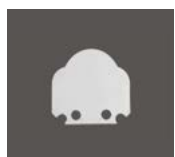

002.024.8021
Testata fascio stretto.
Narrow beam endcap.



032.024.0001
Clip di fissaggio.
Fixing clip.

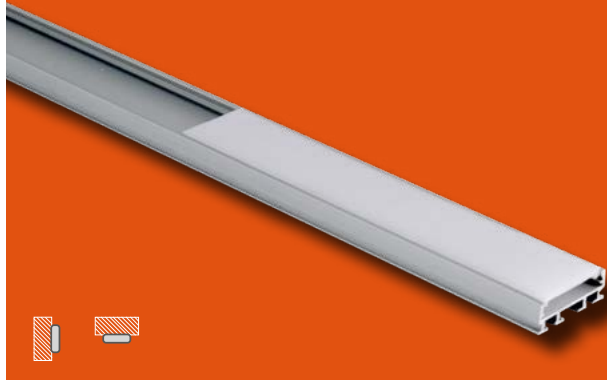

Base 3 profilo da plafone. Disponibile in barre da 2m e 3m. Adatto solo per Strip LED da 6-10mm. Altezza minimale di solo 11.3 mm.

Base 3 surface profile. Available in 2m and 3m lengths. Suitable for 6-10mm tapelight only. Height of the profile is only 11.3mm. It is almost invisible and minimal. Easy installation.

BASE 3

COLOR

bianco/white -02
 anodizzato/anodized -05

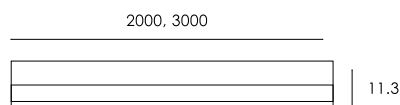
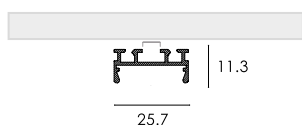

CODICE / CODE

L.MM

COLORE/ COLOR

003.037.2000.05	2000	anodizzato / anodised
003.037.2000.02	2000	bianco / white
003.037.3000.05	3000	anodizzato / anodised
003.037.3000.02	3000	bianco / white

CODICE / CODE

L.MM

DIFFUSORE / DIFFUSER



CODICE / CODE	L.MM	DIFFUSORE / DIFFUSER
005.023.2001.22	2000	opalino / opal
005.023.3001.22	3000	opalino / opal



CODICE / CODE	L.MM	DIFFUSORE / DIFFUSER
005.023.2002.22	2000	opalino / opal
005.023.2002.23	2000	acidato / frosted
005.023.3002.22	3000	opalino / opal
005.023.3002.23	3000	acidato / frosted



CODICE / CODE	L.MM	DIFFUSORE / DIFFUSER
005.023.2003.22	2000	opalino / opal
005.023.2003.23	2000	acidato / frosted
005.023.3003.22	3000	opalino / opal
005.023.3003.23	3000	acidato / frosted



002.037.8020
 Testata piano.
 Flat end cap.

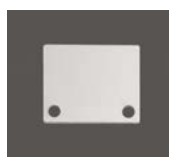

002.037.8022
 Testata quadra.
 Square end cap.

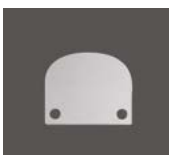

002.037.8021
 Testata tonda.
 Round end cap.



032.023.0001
 Staffa di fissaggio.
 Fixing bracket

Grado angolare profilo da soffitto e parete.
Disponibile in barre da 2m e 3m. Adatto solo per
Strip LED da 6-10mm.
Grado surface profile. Available in 2m and 3m
lengths. Suitable for 6-10mm tapelight only.



- 02- bianco/white
- 05- anodizzato/ anodized

COLOR

GRADO

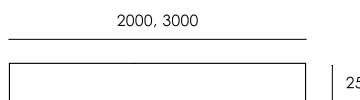
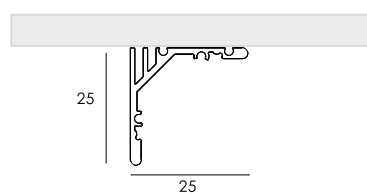

CODICE / CODE	L.MM	COLORE/ COLOR
003.028.2000.05	2000	anodizzato / anodised
003.028.2000.02	2000	bianco / white
003.028.3000.05	3000	anodizzato / anodised
003.028.3000.02	3000	bianco / white

CODICE / CODE	L.MM	DIFFUSORE / DIFFUSER
PIANO/ FLAT		
005.012.2001.22	2000	opalino / opal
005.012.3001.22	3000	opalino / opal
QUADRO/ SQUARE		
005.028.2001.22	2000	opalino / opal
005.028.2001.23	2000	acidato / frosted
005.028.3001.22	3000	opalino / opal
005.028.3001.23	3000	acidato / frosted



002.028.8012
Testata piano.
Flat end cap.



002.028.8011
Testata quadra.
Square end cap.



032.024.0001
Clip di fissaggio.
Fixing clip.

DRIVERS

DRIVERS

CE | IP20 | 



30W

- Pri: 220-240V~50/60Hz
- Sec: 24VDC, 2.90A 70W
- Temperatura di utilizzo / Operating Temp: -40°~+45°C

AAA.TRSL08 30W/24VDC

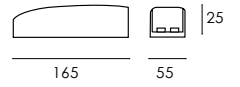

CE | IP20 | 



75W

- Pri: 220-240V~50/60Hz
- Sec: 24VDC, 3.12A 75W
- Temperatura di utilizzo / Operating Temp: -40°~+45°C

AAA.TRSL09 75W/24VDC

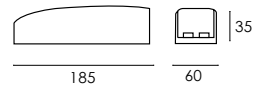

CE | IP20 | 



8W 75W

- Pri: 220-240V~50/60Hz
- Sec: 24VDC, 8W
- Temperatura di utilizzo / Operating Temp: -25°~+60°C

AAA.TRSL14 8W/24VDC

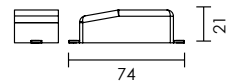

DRIVERS

CE | IP66 | 



10W

- Pri: 220-240V~50/60Hz
- Sec: 24V, 0.8A
- Temperatura di utilizzo / Operating Temp: -10°~+50°C

AAA.TRSL15 10W/24VDC

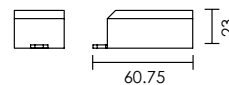

CE | IP67 | 



70W

- Pri: 220-240V~50/60Hz
- Sec: 24VDC, 2.90A 70W
- Temperatura di utilizzo / Operating Temp: -40°~+45°C

AAA.TRSL13 70W/24VDC

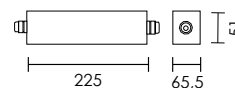

CE | IP67 | 



150W

- Pri: 220-240V~50/60Hz
- Sec: 24VDC, 12.5A 75W
- Temperatura di utilizzo / Operating Temp: -10°~+60°C

AAA.TRSL16 150W/24VDC

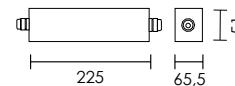

CORRENTE COSTANTE CONSTANT CURRENT

CE | IP20 | 



3W

350mA

- Pri: 220-240V~50/60Hz 0.08A
- Sec:350mA, 2.5 - 10.5V
- Temp. di utilizzo /
Operating Temp: -5°~+50°C

AAA.TRSL00 3W/350mA

AAA.TRSL30 3W/700mA

700mA

- Pri: 220-240V~50/60Hz 0.08A
- Sec:700mA, 2.8 - 10.5V
- Temp. di utilizzo /
Operating Temp: -5°~+50°C



CE | IP20 | 



6W

- Pri: 220-240V~50/60Hz 0.09A
- Sec:500mA, 2 - 17V
- Temp. di utilizzo / Operating Temp: -20°~+50°C

AAA.TRSL41 6W/500mA

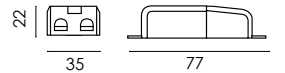

CE | IP20 | 



20W

350mA

- Pri: 220-240V~50/60Hz 0.14A
- Sec:350mA, 2 - 58V
- Temp. di utilizzo /
Operating Temp: -20°~+50°C

AAA.TRSL05 19W 350/700mA

AAA.TRSL45 20W/500mA

700mA

- Pri: 220-240V~50/60Hz 0.14A
- Sec:700mA, 2 - 29V
- Temp. di utilizzo /
Operating Temp: -5°~+50°C

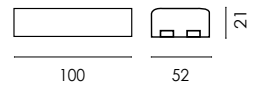

DRIVERS

1. TERMINI DI CONSEGNA

La merce viaggia sempre a rischio e pericolo del committente. Gli ordini verranno evasi in base alle disponibilità e le spedizioni potranno essere fatte anche parzialmente. La merce viene sempre resa franco nostro stabilimento. Nel caso in cui dovessero verificarsi mancanze, manomissioni oppure danneggiamenti della merce, l'acquirente dovrà apporre riserve scritte al trasportatore all'atto della ricezione della merce al fine di avere diritto alla riparazione o reintegrazione. Se tali riserve non venissero apposte al trasportatore, l'acquirente perderà automaticamente il diritto alla reintegrazione o riparazione dei prodotti. Qualsiasi esportazione delle merci acquistate deve essere precedentemente autorizzata dalla CIVIC.

2. RESO DI MERCE

I resi di merce potranno essere accettati soltanto previo accordo scritto formale tra la nostra società e l'acquirente. Tuttavia, tutti quei prodotti non presenti sui listini e cataloghi della nostra società ed oggetto di fabbricazioni o ordini particolari non potranno essere resi in ogni caso. Le spese ed i rischi relativi ai resi di merce rimarranno sempre a carico esclusivo dell'acquirente. Solo dopo una verifica da parte nostra del materiale reso, la nostra società potrà dar luogo ad una nota di credito a favore dell'acquirente o eventualmente alla sostituzione. Rimane inteso che qualsiasi indennità o risarcimento danni a favore dell'acquirente rimarrà esclusa.

3. PAGAMENTI

Si riconoscono solamente i pagamenti fatti direttamente al nostro domicilio o a persone autorizzate, da noi, per iscritto. In caso di ritardato pagamento, totale o parziale, verranno addebitati i relativi interessi di mora. Per qualsiasi somma pagata alla scadenza riportata sulla fattura, si prevede l'applicazione d'interessi moratori pari al tasso BCE +7% (D.lgs 231/2002)

4. RISERVA DI PROPRIETA'

Per pagamento da effettuarsi in tutto o in parte dopo la consegna i prodotti consegnati restano di proprietà del venditore fino al momento del completo pagamento del prezzo, nella misura permessa dalla legge del paese dove i prodotti si trovano. Il compratore per tanto si impegna a fare quanto necessario per costituire nel suddetto paese una valida riserva di proprietà nella forma più estesa consentita, o porre in essere un'analogo forma di garanzia a favore del venditore.

5. LIMITI DI RESPONSABILITA'

I disegni, le quote, i materiali e i colori degli articoli del presente catalogo si intendono a titolo indicativo. Al venditore è riservata la facoltà di modificare o perfezionare i prodotti senza obbligo di preavviso o di comunicazione, in base alle proprie esigenze. Le caratteristiche dei prodotti non sono quindi da considerarsi impegnative. Di conseguenza in nessun caso il venditore potrà essere ritenuto responsabile per danni diretti, indiretti o consequenziali, perdite di produzioni o mancati profitti derivanti da modifiche tecniche ai prodotti. Eventuali esportazioni devono essere autorizzate dalla Civic.

6. FORO COMPETENTE

Per qualsiasi controversia viene riconosciuta la competenza esclusivamente del foro del venditore.

1. DELIVERY TERMS

All goods travel at the Purchaser's own risk. Goods will be delivered in relation to availability and partial orders will also be dispatched. Goods are always delivered ex-factory. On receipt of the goods, any losses, damages or tampering, the purchaser must immediately advise the Carrier concerned in order to obtain the right for the repairing or re-instatement of order. The Purchaser will automatically lose any right to the repairing or re-instatement of their order if this written notice is not submitted to the Carrier. Any export of the purchased goods must be previously authorised by Civic.

2. GOODS RETURNED

Goods can only be returned if previously agreed between the parties. In any case, all the products not included in our price list and catalogue and produced especially for the purchaser, will not be returned. All returns are at risk and cost of the Purchaser. Goods returned will firstly be evaluated before a credit note in favour of the Purchaser will be passed or substitution of the goods. In any case the purchaser shall not be entitled to any indemnity or reimbursement of damages.

3. PAYMENTS

Only payments made directly to our domicile or to persons authorized by ourselves in writing will be accepted. Any delays in payment or partial payments, could result in default interest being charged to the Purchaser. Any amounts outstanding on invoice expiry date, the seller has the right to charge interest at the rate indicated from BCE + 7% (according with D.lgs 231/2002).

4. TITLE RESERVATION

All goods delivered remain the property of the Seller until all payments have been made in full, within the limits of the law of the country where the products are located. Consequently the purchaser will have to do all he can in order to constitute, in the country where the products are located, a property reservation in the most extensive form permitted or to create a similar form of guarantee in favour of the seller. Drawings, sizes, materials and colours of the product contained in this catalogue are purely indicative.

5. MANUFACTURER'S RESPONSIBILITY

The seller will have the right to modify or to improve its products without being obliged to previously advise or inform the other party, in relation with its needs. Technical specifications of products are not binding. Consequently under no circumstances can the Seller be considered responsible for direct, indirect or consequential damages, loss of production or lack of profit. Any exportation must be authorized from Civic.

6. COMPETENT JURISDICTION

The seller's court will be competent for any controversy.

1. DÉLAIS DE LIVRAISON

Les marchandises sont transportées aux risques du client. Les marchandises seront livrées selon disponibilité et livraisons partiels sont permises. Les conditions de livraison sont toujours ex-magasin. Le client doit vérifier immédiatement et soigneusement les marchandises au moment du livraison. Les réclamations éventuelles pour marchandises manquantes ou vices apparents, les litiges ou les contestations sur les marchandises ne sont recevables que si elles sont introduites par lettre directement après réception des marchandises. Sinon le client perd automatiquement le droit à la réparation des marchandises sous garantie ou le remplacement éventuel des marchandises. Tout les exportations de marchandises doivent être précédemment autorisés par Civic.

2. RENVOI DES MARCHANDISES

Aucun renvoi des marchandises n'est accepté sans autorisation préalable par écrit du fournisseur. En tout cas, toutes les marchandises qui ne se trouvent pas sur notre liste de prix et dans notre catalogue, parce que elles sont fabriquées spécialement pour notre client, ne peuvent pas être renvoyées. Le renvoi des marchandises sera au risque et au charge du client. Seulement après un contrôle profonde des marchandises retournées et si notre société estime qu'un renvoi est fondé, nous considerons la possibilité de rédiger une note de crédit ou le remplacement des marchandises. En tout cas l'acheteur des marchandises n'a aucun droit à des dommages-intérêts.

3. PAIEMENT

Toutes les factures sont payables de plein droit sur les comptes bancaires de notre société ou sur les comptes de nos agents, ceci seulement après autorisation écrite de notre part. A défaut de paiement à l'échéance de la facture ou à un paiement partiel de la facture le montant facturé sera majoré de dommages-intérêts. Les factures produiront des intérêts selon la BCE +7% (D.lgs 231/2002) l'an sur les montants non-payés à l'échéance sans que cela nécessite une quelconque mise en demeure.

4. RÉSERVE DE PROPRIÉTÉ

Tant que le client n'a pas entièrement satisfait à ses obligations, notamment tant qu'il n'a pas payé ses dettes, les marchandises fournis par Civic demeurent sa propriété. Par conséquence le client doit faire toutes les actions nécessaires en ordre de constituer, dans le pays de destination sa réserve de propriété ou de créer une garantie en faveur du vendeur. Les formes, dimensions, couleurs des appareils présenté dans ce catalogue sont donnée à titre indicatif.

5. RESPONSABILITÉ DU PRODUCTEUR

Le producteur se garde le droit de modifier ou d'améliorer ses produits sans informer au préalable ses clients. Spécifications techniques ne sont pas considérées contraignant.

Par conséquence le vendeur ne peut être tenu pour responsable, directement ou indirectement, des dommages éventuels de l'acheteur.

L'exportation des produits Civic doit être autorisée.

6. LITIGES

En cas de litige le tribunal du vendeur est compétent et le droit Italien est d'application.

Garanzia / warranty

L'attenzione alla qualità, alla sicurezza e alla durata nel tempo sono tra gli obiettivi fondamentali di CIVIC.
I prodotti sono garantiti per 2 anni (su richiesta per 5 anni), a condizione che siano installati, mantenuti e utilizzati secondo le istruzioni e quanto comunicato nel catalogo o sul nostro sito web.

Sono esclusi dalla garanzia i materiali di consumo come le sorgenti luminose, i driver ed i LED che rispondono alle norme di garanzia espresse dalla Direttiva Europea in materia.

The attention to quality, safety and durability are some of the fundamental objectives of CIVIC.
The products are guaranteed for 2 years (5 years on demand), if the lighting fittings have been installed, maintained and used according to the instructions and as communicated in the catalogue or on our web site.

The warranty excludes consumables goods such as light sources, drivers and LEDs that comply with the warranty standards expressed by the European Directive on the subject.

Civic S.r.l. si riserva il diritto di apportare modifiche ai prodotti contenuti all'interno del catalogo in qualsiasi momento.
Le specifiche come colori e disegni tecnici sono puramente indicativi.

Civic S.r.l. reserves the right to make any changes to the products contained in the catalogue at any moment.
Specifications such as colours and technical drawings are purely indicative.

I prezzi indicati (€ euro) sono IVA esclusa.

All prices (€ euro) are VAT excluded.



Poles

Artisan

Outdoor



Spotlight

Civilis
Light

Led

Lamp

Design

Tappeilight

Worldwide



@CIVICLIGHTING



@CIVICLIGHTING



@CIVIC S.R.L.



WWW.CIVIC.IT

Art Direction
Danae Almeida
Lorenzo Esposito

Printed March 2022

Valido from 1/03/2022
Valido from 1/03/2022

Via Goldoni 48/50
20090 Trezzano S/N
Milan, Italy
Tel. +39 - 0248405581
www.civic.it